

INSTALLATION, OPERATION &
MAINTENANCE MANUAL
FOR
SERIES 330
VERTICAL NON-CLOG PUMPS

20 MAY 2005
Copyright © 2005 American-Marsh Pumps

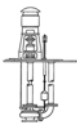

CONTENTS

Page #

SAFETY CONSIDERATIONS 4

DANGER 4

WARNING 4

CAUTION..... 4

PUMP IDENTIFICATION 5

MANUFACTURER 5

TYPE OF PUMP 5

DATE OF MANUFACTURE 5

INSTALLATION, OPERATION & MAINTENANCE MANUAL IDENTIFICATION 5

NAMEPLATE INFORMATION..... 5

WARRANTY 6

GENERAL INSTRUCTIONS..... 6

HANDLING AND TRANSPORT 6

METHOD OF TRANSPORT 6

INSTALLATION 6

STORAGE..... 6

SHORT-TERM STORAGE 6

LONG-TERM STORAGE..... 7

INSTALLATION & ALIGNMENT 7

FACTORY PRELIMINARY ALIGNMENT PROCEDURE..... 7

RECOMMENDED PROCEDURE FOR BASE PLATE INSTALLATION & FINAL FIELD ALIGNMENT 8

NEW GROUTED BASE PLATES 8

EXISTING GROUTED BASE PLATES..... 9

PIPING CONNECTION – SUCTION & DISCHARGE 9

SUCTION PIPING..... 9

DISCHARGE PIPING 10

PUMP AND SHAFT ALIGNMENT CHECK..... 10

IMPELLER CLEARANCES..... 10

MECHANICAL SEAL 10

PACKING..... 10

PIPING CONNECTION –SEAL/PACKING SUPPORT SYSTEM 11

BEARING LUBRICATION 11

GREASE LUBRICATED BEARINGS 11

DRIVER BEARINGS..... 11

COUPLING 11

PUMP OPERATION 11

ROTATION CHECK..... 11

PRE START-UP CHECKS..... 11

ENSURING PROPER NPSH_A 12

MINIMUM FLOW 12

STARTING THE PUMP AND ADJUSTING FLOW 12

OPERATION IN SUB-FREEZING CONDITIONS..... 13

SHUTDOWN CONSIDERATIONS 13

TROUBLESHOOTING 13

MAINTENANCE..... 18

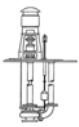

PREVENTIVE MAINTENANCE..... 18

NEED FOR MAINTENANCE RECORDS 18

NEED FOR CLEANLINESS..... 18

DISASSEMBLY 18

NKS & WS MODELS 18

CLEANING/INSPECTION 19

ASSEMBLY 19

NKS & WS THRUST BEARING ASSEMBLY..... 21

BEARING INSTALLATION 21

LABYRINTH SEALS 22

NKS & WS WET END ASSEMBLY 22

PUMP REINSTALLATION..... 23

SPARE PARTS..... 23

 RECOMMENDED SPARE PARTS – STANDARD OSD PUMP 23

 HOW TO ORDER SPARE PARTS 23

APPENDIX B 24

 AMERICAN-MARSH NKS & WS MAINTENANCE INSTRUCTIONS BEARING HOUSING OIL SEALS (LABYRINTH TYPE) INPRO/SEAL® VBXX BEARING ISOLATORS..... 24

INTRODUCTION 24

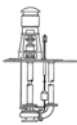

SAFETY CONSIDERATIONS

The American-Marsh NKS & WS vertical process pumps have been designed and manufactured for safe operation. In order to ensure safe operation, it is very important that this manual be read in its entirety prior to installing or operating the pump. American-Marsh Pumps shall not be liable for physical injury, damage or delays caused by a failure to observe the instructions for installation, operation and maintenance contained in this manual.

Remember that every pump has the potential to be dangerous, because of the following factors:

- parts are rotating at high speeds
- high pressures may be present
- high temperatures may be present
- highly corrosive and/or toxic chemicals may be present

Paying constant attention to safety is always extremely important. However, there are often situations that require special attention. These situations are indicated throughout this book by the following symbols:



DANGER - Immediate hazards which WILL result in severe personal injury or death.



WARNING – Hazards or unsafe practices which COULD result in severe personal injury or death.



CAUTION – Hazards or unsafe practices which COULD result in minor personal injury or product or property damage.

Maximum Lifting Speed: 15 feet/second.

If in a climate where the fluid in the casing could freeze, never leave liquid in the pump casing. Drain the casing

completely. During winter months and cold weather, the liquid could freeze and damage the pump casing.

Do not run the equipment dry or start the pump without the proper prime (casing flooded).

Never operate the pump for more than a short interval with the discharge valve closed. The length of the interval depends on several factors including the nature of the fluid pumped and its temperature. Contact American-Marsh Engineering for additional support if required.

Never operate the pump with a closed suction valve.

Excessive pump noise or vibration may indicate a dangerous operating condition. The pump must be shutdown immediately.

Do not operate the pump for an extended period of time below the recommended minimum flow. See Figure 4, page 12.

The pump shaft MUST turn clockwise when viewed from the motor end. It is absolutely essential that the rotation of the motor be checked before installation of the coupling spacer and starting the pump. Incorrect rotation of the pump for even a short period of time can unscrew the impeller nut, which can cause severe damage.

If the liquid is hazardous, take all necessary precautions to avoid damage and injury before emptying the pump casing.

Residual liquid may be found in the pump casing, head and suction line. Take the necessary precautions if the liquid is hazardous, flammable, corrosive, poisonous, infected, etc.

Always lockout power to the driver before performing pump maintenance.

Never operate the pump without the coupling guard and all other safety devices correctly installed.

Do not apply heat to disassemble the pump or to remove the impeller. Entrapped liquid could cause an explosion.

If any external leaks are found while pumping hazardous product, immediately stop operations and repair.

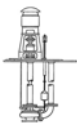

PUMP IDENTIFICATION

MANUFACTURER

American-Marsh Pumps
185 Progress Road
Collierville, TN 38017
United States of America

TYPE OF PUMP

The American-Marsh NKS & WS vertical non-clog pumps are end suction, single stage centrifugal pumps. NKS & WS pumps are of the vertical, wet pit type.

NAMEPLATE INFORMATION

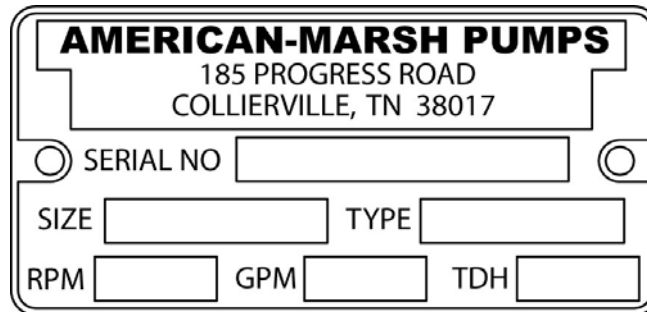

FIGURE 1 – Pump Data Plate

- SERIAL NUMBER : Serial Number of pump unit (issued by Production Control).
- SIZE : Size designation of pump (4x5-10 NKS)
- TYPE : Pump type (NKS or WS).
- RPM : Speed of pump.
- GPM : Rated capacity of pump.
- TDH : Rated Total Dynamic Head of pump.

DATE OF MANUFACTURE

The date of manufacture is indicated on the pump data plate.

INSTALLATION, OPERATION & MAINTENANCE MANUAL IDENTIFICATION

Prepared: May, 2005
Revision:

Edition: 02
Date of Revision:

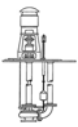

WARRANTY

American-Marsh Pumps guarantees that only high quality materials are used in the construction of our pumps and that machining and assembly are carried out to high standards.

The pumps are guaranteed against defective materials and/or faulty craftsmanship for a period of one year from the date of shipment unless specifically stated otherwise.

Replacement of parts or of the pump itself can only be carried out after careful examination of the pump by qualified personnel.

The warranty is not valid if third parties have tampered with the pump.

This warranty does not cover parts subject to deterioration or wear and tear (mechanical seals, pressure and vacuum gauges, rubber or plastic items, bearings, etc.) or damage caused by misuse or improper handling of the pump by the end user.

Parts replaced under warranty become the property of American-Marsh Pumps.

Contact the American-Marsh Pumps' factory:

American-Marsh Pumps
185 Progress Road
Collierville, TN 38017
United States Of America

Phone: (901) 860-2300
Fax: (901) 860-2323
www.american-marsh.com

GENERAL INSTRUCTIONS

The pump and motor unit must be examined upon arrival to ascertain any damage caused during shipment. If damaged immediately notify the carrier and/or the sender. Check that the goods correspond exactly to the description on the shipping documents and report any differences as soon as possible to the sender. Always quote the pump type and serial number stamped on the data plate.

The pumps must be used only for applications for which the manufacturers have specified:

- ❖ **The construction materials**
- ❖ **The operating conditions (flow, pressure, temperature, etc.)**
- ❖ **The field of application**

In case of doubt, contact the manufacturer.

HANDLING AND TRANSPORT

METHOD OF TRANSPORT

The pump must be transported in the horizontal position

INSTALLATION

During installation and maintenance, all components must be handled and transported securely by using suitable slings. Handling must be carried out by specialized personnel to avoid damage to the pump and persons. The lifting rings attached to various components should be used exclusively to lift the components for which they have been supplied.



Maximum lifting speed: 15 feet/second

STORAGE

SHORT-TERM STORAGE

Normal packaging is designed to protect the pump during shipment and for dry, indoor storage for up to two months or less. The procedure followed for this short-term storage is summarized below:

Standard Protection for Shipment :

- a. Loose unmounted items, including, but not limited to, oilers, packing, coupling spacers, stilts, and mechanical seals are packaged in a water proof plastic bag and placed under the coupling guard. Larger items are cartoned and metal banded to the base plate. For pumps not mounted on a base plate, the bag and/or carton is placed inside the shipping carton. All parts bags and cartons are identified with the American-Marsh sales order number, the customer purchase order number, and the pump item number (if applicable).
- b. Inner surfaces of the bearing housing, shaft (area through bearing housing), and bearings are coated with Cortec VCI-329 rust inhibitor, or equal.
Note: Bearing housings are not filled with oil prior to shipment.
- c. Regreasable bearings are packed with grease (Royal Purple NLGI#2).
- d. After a performance test, if required, the pump is tipped on the suction flange for drainage (some residual water may remain in the casing). Then, internal surfaces of ferrous casings, covers,

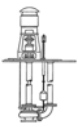

flange faces, and the impeller surface are sprayed with Calgon Vestal Labs RP-743m, or equal. Exposed shafts are taped with Polywrap.

- e. Flange faces are protected with plastic covers secured with plastic drive bolts. 3/16 in (7.8 mm) steel or 1/4 in (6.3 mm) wood covers with rubber gaskets, steel bolts, and nuts are available at extra cost.
- f. All assemblies are bolted to a wood skid which confines the assembly within the perimeter of the skid.
- g. Assemblies with special paint are protected with a plastic wrap.
- h. Group 1 and Group 2 bare pumps, when not mounted on base plates, are packed in hard paper cartons mounted on wood skids.
- i. Group 3 bare pumps, when not mounted on base plates, are bolted to wood skids.
- j. All pump assemblies utilizing polycrystalline base plates are mounted on wood skids.
- k. All assemblies having external piping (seal flush and cooling water plans), etc. are packaged and braced to withstand normal handling during shipment. In some cases components may be disassembled for shipment. The pump must be stored in a covered, dry location.

LONG-TERM STORAGE

Long-term storage is defined as more than two months, but less than 12 months. The procedure American-Marsh follows for long-term storage of pumps is given below. These procedures are in addition to the short-term procedure.

Solid wood skids are utilized. Holes are drilled in the skid to accommodate the anchor bolt holes in the base plate, or the casing and bearing housing feet holes on assemblies less base plate. Tackwrap sheeting is then placed on top of the skid and the pump assembly is placed on top of the Tackwrap. Metal bolts with washers and rubber bushings are inserted through the skid, the Tackwrap, and the assembly from the bottom of the skid and are then secured with hex nuts. When the nuts are “snugged” down to the top of the base plate or casing and bearing housing feet, the rubber bushing is expanded, sealing the hole from the atmosphere. Desiccant bags are placed on the Tackwrap. The Tackwrap is drawn up around the assembly and hermetically (heat) sealed across the top. The assembly is completely sealed from the atmosphere and the desiccant will absorb any entrapped moisture. A solid wood box is then used to cover the assembly to provide protection from the elements and handling. This packaging will provide protection up to twelve months without damage to mechanical seals, bearings, lip seals, etc. due to humidity, salt laden air, dust, etc. After unpacking, protection will be the responsibility of the ENGINEERED PROCESS GROUP

user. Addition of oil to the bearing housing will remove the inhibitor. If units are to be idle for extended periods after addition of lubricants, inhibitor oils and greases should be used.

Every three months, the shaft should be rotated approximately 10 revolutions.

INSTALLATION & ALIGNMENT

FACTORY PRELIMINARY ALIGNMENT PROCEDURE

The purpose of factory alignment is to ensure that the user will have full utilization of the clearance in the motor holes for final job-site alignment. To achieve this, the factory alignment procedure specifies that the pump be aligned in the horizontal plane to the motor, with the motor foot bolts centered in the motor holes. This procedure ensures that there is sufficient clearance in the motor holes for the customer to field align the motor to the pump, to zero tolerance. This philosophy requires that the customer be able to place the base in the same condition as the factory. Thus the factory alignment will be done with the base sitting in an unrestrained condition on a flat and level surface. This standard also emphasizes the need to ensure the shaft spacing is adequate to accept the specified coupling spacer. The factory alignment procedure is summarized below:

1. The base plate is placed on a flat and level work bench in a free and unstressed position.
2. The base plate is leveled as necessary. Leveling is accomplished by placing shims under the rails (or, feet) of the base at the appropriate anchor bolt hole locations. Levelness is checked in both the longitudinal and lateral directions.
3. The motor and appropriate motor mounting hardware is placed on the base plate and the motor is checked for any planar soft-foot condition. If any is present it is eliminated by shimming.
4. The motor feet holes are centered around the motor mounting fasteners.
5. The motor is fastened in place by tightening the nuts on two diagonal motor mounting studs.
6. The pump is put onto the base plate and leveled. The foot piece under the bearing housing is adjustable. It is used to level the pump, if necessary. If an adjustment is necessary, we add or delete shims (#109A) between the foot piece and the bearing housing.
7. The spacer coupling gap is verified.

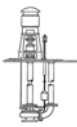

8. The parallel and angular *vertical* alignment is made by shimming under the motor.
9. All four motor feet are tightened down.
10. The pump and motor shafts are then aligned *horizontally*, both parallel and angular, by *moving the pump* to the fixed motor. The pump feet are tightened down.
11. Both horizontal and vertical alignment are again final checked as is the coupling spacer gap.

RECOMMENDED PROCEDURE FOR BASE PLATE INSTALLATION & FINAL FIELD ALIGNMENT

NEW GROUDED BASE PLATES

1. The pump foundation should be located as close to the source of the fluid to be pumped as practical. There should be adequate space for workers to install, operate, and maintain the pump. The foundation should be sufficient to absorb any vibration and should provide a rigid support for the pump and motor. Recommended mass of a concrete foundation should be three times that of the pump, motor and base. Note that foundation bolts are imbedded in the concrete inside a sleeve to allow some movement of the bolt.
2. Level the pump base plate assembly. If the base plate has machined coplanar mounting surfaces, these machined surfaces are to be referenced when leveling the base plate. This may require that the pump and motor be removed from the base plate in order to reference the machined faces. If the base plate is without machined coplanar mounting surfaces, the pump and motor are to be left on the base plate. The proper surfaces to reference when leveling the pump base plate assembly are the pump suction and discharge flanges. **DO NOT** stress the base plate. Do not bolt the suction or discharge flanges of the pump to the piping until the base plate foundation is completely installed. If equipped, use leveling jackscrews to level the base plate. If jackscrews are not provided, shims and wedges should be used (see Figure 2). Check for levelness in both the longitudinal and lateral directions. Shims should be placed at all base anchor bolt locations, and in the middle edge of the base if the base is more than five feet long. Do not rely on the bottom of the base plate to be flat. Standard base plate bottoms are not machined, and it

is not likely that the field mounting surface is flat.

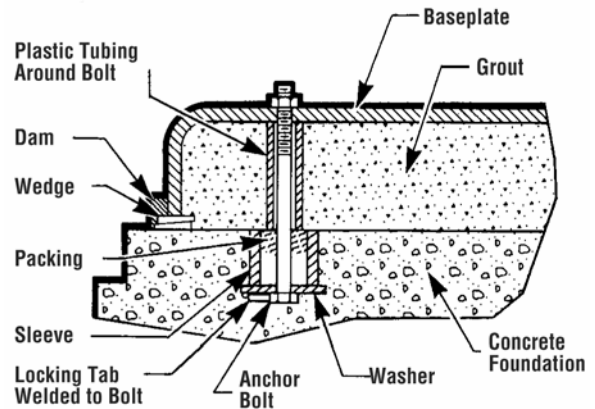
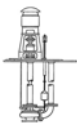

FIGURE 2 – Base Plate Foundation

3. After leveling the base plate, tighten the anchor bolts. If shims were used, make sure that the base plate was shimmed near each anchor bolt before tightening. Failure to do this may result in a twist of the base plate, which could make it impossible to obtain final alignment. Check the level of the base plate to make sure that tightening the anchor bolts did not disturb the level of the base plate. If the anchor bolts did change the level, adjust the jackscrews or shims as needed to level the base plate. Continue adjusting the jackscrews or shims and tightening the anchor bolts until the base plate is level.
4. Check initial alignment. If the pump and motor were removed from the base plate proceed with step 5 first, then the pump and motor should be reinstalled onto the base plate using American-Marsh's Factory Preliminary Alignment Procedure, and then continue with the following. As described above, pumps are given a preliminary alignment at the factory. This preliminary alignment is done in a way that ensures that, if the installer duplicates the factory conditions, there will be sufficient clearance between the motor hold down bolts and motor foot holes to move the motor into final alignment. If the pump and motor were properly reinstalled to the base plate or if they were not removed from the base plate and there has been no transit damage, and also if the above steps were done properly, the pump and driver should be within 0.015 in (0.38 mm) FIM (Full Indicator Movement) parallel, and 0.0025 in/in (0.0025 mm/mm) FIM angular. If this is not the case first



check to see if the driver mounting fasteners are centered in the driver feet holes. If not, recenter the fasteners and perform a preliminary alignment to the above tolerances by shimming under the motor for vertical alignment, and by moving the pump for horizontal alignment.

5. Grout the base plate. A non-shrinking grout should be used. Make sure that the grout fills the area under the base plate. After the grout has cured, check for voids and repair them. Jackscrews, shims and wedges should be removed from under the base plate at this time. If they were to be left in place, they could rust, swell, and cause distortion in the base plate.
6. Run piping to the suction and discharge of the pump. There should be no piping loads transmitted to the pump after connection is made. Recheck the alignment to verify that there are no significant loads.
7. Perform final alignment. Check for soft-foot under the driver. An indicator placed on the coupling, reading in the vertical direction, should not indicate more than 0.002 in (0.05 mm) movement when any driver fastener is loosened. Align the driver first in the vertical direction by shimming underneath its feet. When satisfactory alignment is obtained the number of shims in the pack should be minimized. It is recommended that no more than five shims be used under any foot. Final horizontal alignment is made by moving the driver. Maximum pump reliability is obtained by having near perfect alignment. American-Marsh recommends no more than 0.002 in (0.05mm) parallel, and 0.0005 in/in (0.0005 mm/mm) angular misalignment.
8. Operate the pump for at least an hour or until it reaches final operating temperature. Shut the pump down and recheck alignment while the pump is hot. Piping thermal expansion may change the alignment. Realign pump as necessary.

EXISTING GROUDED BASE PLATES

When a pump is being installed on an existing grouted base plate, the procedure is somewhat different from the previous section "New Grouted Base Plates."

1. Mount the pump on the existing base plate.
2. Level the pump by putting a level on the discharge flange. If not level, add or delete shims (#109A) between the foot piece and the bearing housing.
3. Check initial alignment. (Step 4 above)

ENGINEERED PROCESS GROUP

4. Run piping to the suction and discharge flanges of the pump. (Step 6 above)
5. Perform final alignment. (Step 7 above)
6. Recheck alignment after pump is hot. (Step 8 above)

All piping must be independently supported, accurately aligned and preferably connected to the pump by a short length of flexible piping. The pump should not have to support the weight of the pipe or compensate for misalignment. It should be possible to install suction and discharge bolts through mating flanges without pulling or prying either of the flanges. All piping must be tight. Pumps may air-bind if air is allowed to leak into the piping. If the pump flange(s) have tapped holes, select flange fasteners with thread engagement at least equal to the fastener diameter but that do not bottom out in the tapped holes before the joint is tight.

PIPING CONNECTION – SUCTION & DISCHARGE

All piping must be independently supported, accurately aligned and preferably connected to the pump by a short length of flexible piping. The pump should not have to support the weight of the pipe or compensate for misalignment. It should be possible to install suction and discharge bolts through mating flanges without pulling or prying either of the flanges. All piping must be tight. Pumps may air-bind if air is allowed to leak into the piping. If the pump flange(s) have tapped holes, select flange fasteners with thread engagement at least equal to the fastener diameter but that do not bottom out in the tapped holes before the joint is tight.



Piping Forces: Take care during installation and operation to minimize pipe forces and/or moments on the pump casing.

SUCTION PIPING

To avoid NPSH and suction problems, suction pipe sizes must be at least as large as the pump suction connection. **Never** use pipe or fittings on the suction that are smaller in diameter than the pump suction size. Figure 3 illustrates the ideal piping configuration with a minimum of 10 pipe diameters between the source and the pump suction. In most cases, horizontal reducers should be eccentric and mounted with the flat side up as shown in figure 6 with a maximum of one pipe size reduction. Never mount eccentric reducers with the flat side down. Horizontally mounted concentric reducers should not be used if there is any possibility of entrained air in the process fluid. Vertically mounted concentric

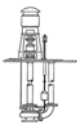

reducers are acceptable. In applications where the fluid is completely deaerated and free of any vapor or suspended solids, concentric reducers are preferable to eccentric reducers.

Avoid the use of throttling valves and strainers in the suction line. Start up strainers must be removed shortly after start up. When the pump is installed below the source of supply, a valve should be installed in the suction line to isolate the pump and to permit pump inspection and maintenance. However, never place a valve directly on the suction nozzle of the pump.

Refer to the American-Marsh Pump Engineering Manual and the Centrifugal Pump IOM Section of the Hydraulic Institute Standards for additional recommendations on suction piping.

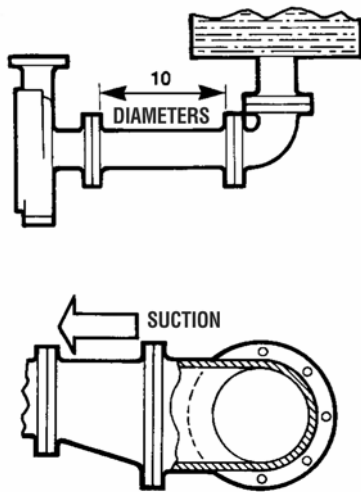

FIGURE 3 – Good Piping Practices

DISCHARGE PIPING

Install a valve in the discharge line. This valve is required for regulating flow and/or to isolate the pump for inspection and maintenance.

! WARNING

When fluid velocity in the pipe is high, for example, 10 ft/s (3 m/s) or higher, a rapidly closing discharge valve can cause a damaging pressure surge. A dampening arrangement should be provided in the piping.

PUMP AND SHAFT ALIGNMENT CHECK

After connecting piping, rotate the pump drive shaft clockwise (view from motor end) by hand several complete revolutions to be sure there is no binding and that all parts are free. Recheck shaft alignment. If piping caused unit to be out of alignment, correct piping to relieve strain on the pump.

IMPELLER CLEARANCES

NKS & WS model pumps have impeller clearances that need to be adjusted. The impeller needs to be adjusted 0.020 inches to 0.030 inches off of the rear cover. The design and assembly of the thrust bearing housing ensure that the impeller is placed in the proper position within the casing assembly. These clearances are set at the factory and initial setting in the field is not required.

MECHANICAL SEAL

When the pump is intended to be equipped with a mechanical seal, it is American-Marsh’s standard practice to install the mechanical seal in the pump prior to shipment. Specific order requirements may specify that the seal be shipped separately, or none be supplied. It is the pump installer’s responsibility to determine if a seal was installed. If a seal was supplied but not installed, the seal and installation instructions will be shipped with the pump.

! WARNING

Failure to ensure that a seal is installed may result in serious leakage of the pumped fluid.

Seal and seal support system must be installed and operational as specified by the seal manufacturer.

The stuffing box/seal chamber/gland may have ports that have been temporarily plugged at the factory to keep out foreign matter. It is the installer’s responsibility to determine if these plugs should be removed and external piping connected. Refer to the seal drawings and/or the local American-Marsh representative for the proper connections.

PACKING

When the pump is intended to be equipped with shaft packing, it is not American-Marsh’s standard practice to install the packing in the stuffing box prior to shipment. The packing is shipped with the pump. It is the pump installer’s responsibility to install the packing in the stuffing box.

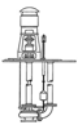

WARNING

Failure to ensure that packing is installed may result in serious leakage of the pumped fluid.

PIPING CONNECTION –SEAL/PACKING SUPPORT SYSTEM

WARNING

If the pump has a seal support system, it is mandatory that this system be fully installed and operational before the pump is started.

BEARING LUBRICATION

Reasonable care and proper lubrication of American-Marsh Pump bearings will result in many years of service.

GREASE LUBRICATED BEARINGS

NKS & WS pumps are supplied with grease packed bearings and are shipped from the factory pre-lubricated. Before the pump is started the bearings must be filled with Royal Purple NLGI #2 or other high quality equivalent grease.

DRIVER BEARINGS

Consult the driver manufacturer’s maintenance instructions for lubricants and re-lubrication procedures for the driver.

COUPLING

A direction arrow is cast on the front of the casing and on the Bearing Housing. Make sure the motor rotates in the same direction before coupling the motor to the Pump.

CAUTION

It is absolutely essential that the rotation of the motor be checked before connecting the shaft coupling. Incorrect rotation of the pump, for even a short time, can dislodge the impeller which may cause serious damage to the

pump. All RE pumps turn clockwise as viewed from the motor end or, conversely, counterclockwise when viewed from the suction end.

The coupling should be installed as advised by the coupling manufacturer. Pumps are shipped without the spacer installed. If the spacer has been installed to facilitate alignment, then it must be removed prior to checking rotation. Remove protective material from the coupling and any exposed portions of the shaft before installing the coupling.

PUMP OPERATION

ROTATION CHECK

CAUTION

It is absolutely essential that the rotation of the motor be checked before connecting the shaft coupling. Incorrect rotation of the pump, for even a short time, can dislodge and damage the impeller, casing, shaft and shaft seal.

All NKS & WS pumps turn clockwise as viewed from the motor end. A direction arrow is cast on the front of the casing. Make sure the motor rotates in the same direction.

PRE START-UP CHECKS

Prior to starting the pump it is essential that the following checks are made. These checks are all described in detail in the Maintenance Section of this booklet.

- Pump and Motor properly secured to the base plate
- All fasteners tightened to the correct torques
- Coupling guard in place and not rubbing
- Rotation check, see above

THIS IS ABSOLUTELY ESSENTIAL.

- Shaft seal properly installed
- Seal support system operational
- Bearing lubrication
- Bearing housing cooling system operational
- Impeller clearances properly set
- Pump instrumentation is operational
- Pump is primed
- Rotation of shaft by hand

As a final step in preparation for operation, it is important to rotate the shaft by hand to be certain that all rotating parts move freely, and that there are no foreign objects in the pump.

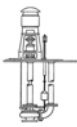

ENSURING PROPER NPSH_A

Net Positive Suction Head – Available (NPSH_A) is the measure of the energy in a liquid above the vapor pressure. It is used to determine the likelihood that a fluid will vaporize in the pump. It is critical because a centrifugal pump is designed to pump a liquid, not a vapor. Vaporization in a pump will result in damage to the pump, deterioration of the Total Differential Head (TDH), and possibly a complete stopping of pumping. Net Positive Suction Head – Required (NPSH_R) is the decrease of fluid energy between the inlet of the pump, and the point of lowest pressure in the pump. This decrease occurs because of friction losses and fluid accelerations in the inlet region of the pump, and particularly accelerations as the fluid enters the impeller vanes. The value for NPSH_R for the specific pump purchased is given in the pump data sheet, and on the pump performance curve.

For a pump to operate properly the NPSH_A must be greater than the NPSH_R. Good practice dictates that this margin should be at least 5 ft (1.5 m) or 20%, whichever is greater.

CAUTION

Ensuring that NPSH_A is larger than NPSH_R by the suggested margin will greatly enhance pump performance and reliability. It will also reduce the likelihood of cavitation, which can severely damage the pump.

MINIMUM FLOW

Minimum continuous stable flow is the lowest flow at which the pump can operate and still conform to the bearing life, shaft deflection and bearing housing vibration limits. Pumps may be operated at lower flows, but it must be recognized that the pump may not conform to one or more of these limits. For example, vibration may exceed the limit set by the ASME standard. The size of the pump, the energy absorbed, and the liquid pumped are some of the considerations in determining the minimum flow.

Typically, limitations of 10% of the capacity at the best efficiency point (BEP) should be specified as the minimum flow. However, American-Marsh has determined that several pumps must be limited to higher minimum flows to provide optimum service. The following are the recommended minimum flows for these specific pumps:

Pump Size	60 Hz		50 Hz	
	RPM	Minimum Flow (% of BEP)	RPM	Minimum Flow (% of BEP)
All 5" Impellers	3500	25%	2900	21%
All 7" Impellers	3500	25%	2900	21%
All 8" Impellers	3500	25%	2900	21%
All 10" Impellers	3500	33%	2900	28%
All 13" Impellers	1750	50%	1450	42%
All Other Sizes	ANY	20%	ANY	20%

FIGURE 4 - Minimum Continuous Safe Flow

Note: "Minimum intermittent flow" value of 50% of the "minimum continuous flow" as long as that flow is greater than the "minimum thermal flow."

All NKS & WS pumps also have a "Minimum Thermal Flow." This is defined as the minimum flow that will not cause an excessive temperature rise. Minimum Thermal Flow is application dependent.

WARNING

Do not operate the pump below Minimum Thermal Flow, as this could cause an excessive temperature rise. Contact an American-Marsh Sales Engineer for determination of Minimum Thermal flow.

STARTING THE PUMP AND ADJUSTING FLOW

1. Open the suction valve to full open position. It is very important to leave the suction valve open while the pump is operating. Any throttling or adjusting of flow must be done through the discharge valve. Partially closing the suction valve can create serious NPSH and pump performance problems.

DANGER

Never operate pump with both the suction and discharge valves closed. This could cause an explosion.

2. A standard centrifugal pump will not move liquid unless the pump is primed. A pump is said to be "primed" when the casing and the suction piping are completely filled with liquid. Open discharge valve a slight amount. This will allow any entrapped air to escape and will normally allow

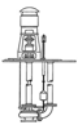

the pump to prime, if the suction source is above the pump. When a condition exists where the suction pressure may drop below the pump's capability, it is advisable to add a low pressure control device to shut the pump down when the pressure drops below a predetermined minimum.

3. All cooling, heating, and flush lines must be started and regulated.
4. Start the driver (typically, the electric motor).
5. Slowly open the discharge valve until the desired flow is reached, keeping in mind the minimum flow restrictions listed above.

! DANGER

It is important that the discharge valve be opened within a short interval after starting the driver. Failure to do this could cause a dangerous build up of heat, and possibly an explosion.

6. **Reduced capacity**
Avoid running a centrifugal pump at drastically reduced capacities or with discharge valve closed for extended periods of time. This can cause severe temperature rise and the liquid in the pump may reach its boiling point. If this occurs, the mechanical seal will be exposed to vapor, with no lubrication, and may score or seize to the stationary parts. Continued running under these conditions when the suction valve is also closed, can create an explosive condition due to the confined vapor at high pressure and temperature. Thermostats may be used to safeguard against over heating by shutting down the pump at a predetermined temperature.

Safeguards should also be taken against possible operation with a closed discharge valve, such as installing a bypass back to the suction source. The size of the bypass line and the required bypass flow rate is a function of the input horsepower and the allowable temperature rise.

7. **Reduced Head**
Note that when discharge head drops, the pump's flow rate usually increases rapidly. Check motor for temperature rise as this may cause overload. If overloading occurs, throttle the discharge.
8. **Surging Condition**
A rapidly closing discharge valve can cause a damaging pressure surge. A dampening arrangement should be provided in the piping.

OPERATION IN SUB-FREEZING CONDITIONS

When using the pump in sub-freezing conditions where the pump is periodically idle, the pump should be properly drained or protected with thermal devices which will keep the liquid in the pump from freezing.

SHUTDOWN CONSIDERATIONS

When the pump is being shutdown, the procedure should be the reverse of the start-up procedure. First, slowly close the discharge valve, shutdown the driver, then close the suction valve. Remember, closing the suction valve while the pump is running is a safety hazard and could seriously damage the pump and other equipment.

TROUBLESHOOTING

The following is a guide to troubleshooting problems with American-Marsh pumps. Common problems are analyzed and solutions are offered. Obviously, it is impossible to cover every possible scenario. If a problem exists that is not covered by one of the examples, then contact a local American-Marsh Sales Engineer or Distributor/Representative for assistance.

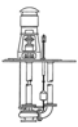

PROBLEM	POSSIBLE CAUSE	RECOMMENDED REMEDY
Problem #1 Pump not reaching design flow rate.	1.1 Insufficient NPSH _A . (Noise may not be present)	Recalculate NPSH available. It must be greater than the NPSH required by pump at desired flow. If not, redesign suction piping, holding number of elbows and number of planes to a minimum to avoid adverse flow rotation as it approaches the impeller.
	1.2 System head greater than anticipated.	Reduce system head by increasing pipe size and/ than or reducing number of fittings. Increase impeller diameter. NOTE: Increasing impeller diameter may require use of a larger motor.
	1.3 Entrained air. Air leak from atmosphere on suction side.	1. Check suction line gaskets and threads for tightness. 2. If vortex formation is observed in suction tank, install vortex breaker. 3. Check for minimum submergence.
	1.4 Entrained gas from process.	Process generated gases may require larger pumps.
	1.5 Speed too low.	Check motor speed against design speed.
	1.6 Direction of rotation wrong.	After confirming wrong rotation, reverse any two of three leads on a three phase motor. The pump should be disassembled and inspected before it is restarted.
	1.7 Impeller too small.	Replace with proper diameter impeller. NOTE: Increasing impeller diameter may require use of a larger motor.
	1.8 Plugged impeller, suction line or casing which may be due to a product or large solids.	1. Reduce length of fiber when possible. 2. Reduce solids in the process fluid when possible. 3. Consider larger pump.
	1.9 Wet end parts (casing cover, impeller) worn, corroded or missing.	Replace part or parts.
Problem #2.0 Pump not reaching design head (TDH).	2.1 Refer to possible causes under Problem #1.0.	Refer to remedies listed under Problem #1.0 and #3.0.
Problem #3.0 No discharge or flow	3.1 Not properly primed.	Repeat priming operation, recheck instructions. If pump has run dry, disassemble and inspect the pump before operation.
	3.2 Direction of rotation wrong.	After confirming wrong rotation, reverse any two of three leads on a three phase motor. The pump should be disassembled and inspected before operation.

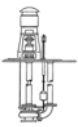

PROBLEM	POSSIBLE CAUSE	RECOMMENDED REMEDY
Cont. Problem #3.0 No discharge or flow	3.3 Entrained air. Air leak from atmosphere on suction side.	Refer to recommended remedy under Problem #1.0, Item #1.3.
	3.4 Plugged impeller, suction line or casing which may be due to a fibrous product or large solids.	Refer to recommended remedy under Problem #1.0, Item #1.8.
	3.5 Damaged pump shaft, impeller.	Replace damaged parts.
Problem #4.0 Pump operates for short period, then loses prime.	4.1 Insufficient NPSH.	Refer to recommended remedy under Problem #1.0, Item #1.1.
	4.2 Entrained air. Air leak from atmosphere on suction side.	Refer to recommended remedy under Problem #1.0, Item #1.3.
Problem #5.0 Excessive noise from wet end.	5.1 Cavitation - insufficient NPSH available.	Refer to recommended remedy under Problem #1.0, Item #1.1.
	5.2 Abnormal fluid rotation due to complex suction piping.	Redesign suction piping, holder number of elbows and number of planes to a minimum to avoid adverse fluid rotation as it approaches the impeller.
	5.3 Impeller rubbing.	1. Check thrust bearing assembly for axial end play. 2. Reset impeller clearance.
Problem #6.0 Excessive noise from power end.	6.1 Bearing contamination appearing on the raceways as scoring, pitting, scratching, or rusting caused by adverse environment and entrance of abrasive contaminants from atmosphere.	1. Work with clean tools in clean surroundings. 2. Remove all outside dirt from housing before exposing bearings. 3. Handle with clean dry hands. 4. Treat a used bearing as carefully as a new one. 5. Use clean solvent and flushing oil. 6. Protect disassembled bearing from dirt and moisture. 7. Keep bearings wrapped in paper or clean cloth while not in use. 8. Clean inside of housing before replacing bearings. 9. Check oil seals and replace as required. 10. Check all plugs and tapped openings to make sure that they are tight.
	6.2 Brinelling of bearing identified by indentation on the ball races, usually caused by incorrectly applied forces in assembling the bearing or by shock loading such as hitting the bearing or drive shaft with a hammer.	When mounting the bearing on the drive shaft use a proper size ring and apply the pressure against the inner ring only. Be sure when mounting a bearing to apply the mounting pressure slowly and evenly.

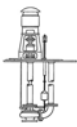

PROBLEM	POSSIBLE CAUSE	RECOMMENDED REMEDY
Cont. Problem #6.0 Excessive noise from power end.	6.3 False brinelling of bearing identified again by either axial or circumferential indentations usually caused by vibration of the balls between the races in a stationary bearing.	1. Correct the source of vibration. 2. Where bearings are oil lubricated and employed in units that may be out of service for extended periods, the drive shaft should be turned over periodically to re-lubricate all bearing surfaces at intervals of one-to three months.
	6.4 Thrust overload on bearing identified by flaking ball path on one side of the outer race or in the case of maximum capacity bearings, may appear as a spalling of the races in the vicinity of the loading slot. (Please note: maximum capacity bearings are not recommended in NKS & WS pumps.) These thrust failures are caused by improper mounting of the bearing or excessive thrust loads.	1. Follow correct mounting procedures for bearings.
	6.5 Misalignment identified by fracture of ball retainer or a wide ball path on the inner race and a narrower cocked ball path on the outer race. Misalignment is caused by poor mounting practices or defective drive shaft. For example bearing not square with the centerline or possibly a bent shaft due to improper handling.	Handle parts carefully and follow recommended mounting procedures. Check all parts for proper fit and alignment.
	6.6 Bearing damaged by electric arcing identified as electro-etching of both inner and outer ring as a pitting or cratering. Electrical arcing is caused by a static electrical charge emanating from belt drives, electrical leakage or short circuiting.	1. Where current shunting through the bearing cannot be corrected, a shunt in the form of a slip ring assembly should be incorporated. 2. Check all wiring, insulation and rotor windings to be sure that they are sound and all connections are properly made. 3. Where pumps are belt driven, consider the elimination of static charges by proper grounding or consider belt material that is less generative.

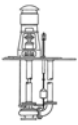

PROBLEM	POSSIBLE CAUSE	RECOMMENDED REMEDY
Cont.: Problem #6.0 Excessive noise from power end.	6.7 Bearing damage due to improper lubrication, identified by one or more of the following: 1. Abnormal bearing temperature rise. 2. A stiff cracked grease appearance. 3. A brown or bluish discoloration of the bearing races.	1. Be sure the lubricant is clean. 2. Be sure proper amount of lubricant is used. The constant level oiler supplied with NKS & WS pumps will maintain the proper oil level if it is installed and operating properly. In the case of greased lubricated bearings, be sure that there is space adjacent to the bearing into which it can rid itself of excessive lubricant, otherwise the bearing may overheat and fail prematurely. 3. Be sure the proper grade of lubricant is used.

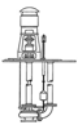

MAINTENANCE

PREVENTIVE MAINTENANCE

The following sections of this manual give instructions on how to perform a complete maintenance overhaul. However, it is also important to periodically repeat the "Pre start-up checks" listed on page 13. These checks will help extend pump life as well as the length of time between major overhauls.

NEED FOR MAINTENANCE RECORDS

A procedure for keeping accurate maintenance records is a critical part of any program to improve pump reliability. There are many variables that can contribute to pump failures. Often long term and repetitive problems can only be solved by analyzing these variables through pump maintenance records.

NEED FOR CLEANLINESS

One of the major causes of pump failure is the presence of contaminants in the bearing housing. This contamination can be in the form of moisture, dust, dirt and other solid particles such as metal chips. Contamination can also be harmful to the mechanical seal (especially the seal faces) as well as other parts of the pumps. For example, dirt in the impeller threads could cause the impeller to not be seated properly against the shaft. This, in turn, could cause a series of other problems. For these reasons, it is very important that proper cleanliness be maintained. Some guidelines are listed below.

After draining the oil from the bearing housing, periodically send it out for analysis. If it is contaminated, determine the cause and correct. The work area should be clean and free from dust, dirt, oil, grease, etc. Hands and gloves should be clean. Only clean towels, rags, and tools should be used.

DISASSEMBLY

Refer to the parts list shown in Figure 10 for item number references used throughout this section.

NKS & WS MODELS

1. Before performing any maintenance, disconnect the driver from its power supply and lock it off line.

! DANGER

Lock out power to driver to prevent personal injury.

2. Close the discharge and suction valves, and drain all liquid from the pump.
3. Close all valves on auxiliary equipment and piping, then disconnect all auxiliary piping.
4. Decontaminate the pump as necessary. If American-Marsh pumps contain dangerous chemicals, it is important to follow plant safety guidelines to avoid personal injury or death.
5. Remove the coupling guard.
6. Remove the spacer from the coupling (if supplied).
7. Loosen and remove the coupling setscrews (#30) and remove the coupling from the shaft. The motor bolts can now be loosened and removed. Remove the motor from the motor bracket (#498A), if necessary.
8. Loosen and remove the bolts that hold the strainer (#424A) to the casing (#1A). Loosen and remove the bolts that hold the casing (#1A) to the inboard head (#2B).
9. At this time any lubrication lines from the cover plate must be removed. The casing (#1A) can be removed from the inboard head (#2B) by first removing the discharge pipe assembly. The discharge assembly consists of the discharge elbow (#441A) and the discharge pipe (#260A). Once the discharge pipe assembly has been removed, remove the bolts from the support pipe (#280A) and remove the casing (#1A) from the inboard head (#2B).
10. Inspect the casing (#1A) and the case wear ring (#15A) for damage. If the casing (#1A) shows any signs of damage, replace it. If the case wear ring (#15A) is damaged, pry it from the casing (#1A). Press new case wear ring (#15A) into casing (#1A) by using equal force around the case wear ring (#15A) until it is seated securely in casing (#1A).
11. Loosen the setscrews in the ball bearing adapter (#92S). With the coupling loose, the shaft (#41A) and impeller (#11C) assembly can now be pulled from the pump assembly.
12. Bend the impeller washer (#27A) flat so that the impeller nut (#24B) can be loosened. Loosen and remove the impeller nut (#24B) and the impeller washer (#27A). Discard the impeller washer (#27A). The impeller (#11A) should be

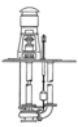

free to remove from the shaft (#41A). Remove the impeller key (#24A) from the shaft (#41A).

be removed from the pump assembly at this time.

CAUTION

Do not apply heat to the impeller. If liquid is entrapped in the hub, an explosion could occur.

13. Loosen and remove the bolts that connect the inboard head (#2B) to the support column (#280A). Remove the inboard head (#2B). At this time the inboard head bushing (#45C) can be inspected and removed if necessary. Pumps equipped with intermediate bushings can also be removed and inspected at this time. Intermediate bushings consist of the intermediate bearing housing (#82R) and the intermediate bearing (#81R).
14. The support column (#280A) can be removed from the coverplate (#221B) at this time if necessary.
15. The thrust bearing assembly can now be removed. Remove the bolts that hold the bearing housing cap (#85S) to the thrust bearing housing (#82S). Remove the thrust bearing adapter (#92S) from the thrust bearing housing (#82S). The thrust bearing (#81S) can be removed from the thrust bearing adapter (#92S) by removing the locknut (#89S) and lockwasher (#91S).
16. At this time the thrust bearing (#81S) and the bearing housing cap (#85S) can be removed and inspected.
17. On units equipped with a stuffing box option, the gland nuts (#72A) and gland (#71A) can be removed. At this time the packing (#331A) can also be removed. The stuffing box (#61A) can be removed from the cover plate (#221B) if necessary. The motor pedestal extension (#499A) can be removed from the cover plate (#221B) if necessary.
18. The bearing housing (#82S) and the motor pedestal (#498A) can be removed from the cover plate (#221B) if necessary.
19. The float switch assembly, if equipped, can be removed from the cover plate (#221B) by removing the bolts that hold the float switch bracket to the cover plate (#221B).
20. The float switch assembly consists of the float switch (#301A), the float (#309A), the float rod guide (#304A), the float rod (#303A), the four float rod stops (#307A), the float switch bracket (#302A) and the float rod box nut (#306A) assembly. The entire float switch assembly can

CLEANING/INSPECTION

All parts should now be thoroughly cleaned and inspected. New bearings, O-rings, gaskets, and lip seals should be used. Any parts that show wear or corrosion should be replaced with new genuine American-Marsh parts.

WARNING

It is important that only non-flammable, non-contaminated cleaning fluids are used. These fluids must comply with plant safety and environmental guidelines.

ASSEMBLY

Note: Refer to Figure 5 for all bolt torque information.

It is very important that all pipe threads be sealed properly. PTFE tape provides a very reliable seal over a wide range of fluids, but it has a serious shortcoming if not used properly. If, during application to the threads, the tape is wrapped over the end of the male thread, strings of the tape will be formed off when threaded into the female fitting. This string can then tear away and lodge in the piping system. If this occurs in the seal flush system, small orifices can become blocked effectively shutting off flow. For this reason, American-Marsh does not recommend the use of PTFE tape as a thread sealant.

American-Marsh has investigated and tested alternate sealants and has identified two that provide an effective seal, have the same chemical resistance as the tape, and will not plug flush systems. These are La-co SlicTite and Bakerseal. Both products contain finely ground PTFE particles in an oil based carrier. They are supplied in a paste form which is brushed on the male pipe threads. American-Marsh recommends using one of these paste sealants.

Full thread length engagement is required for all fasteners.



BOLT SIZE		TIGHTENING TORQUE	
Metric	Standard	Lbf ft	Nm
4 mm	5/32"	2.7	3.6
5 mm	3/16"	5.2	7.0
6 mm	1/4"	8.9	12.0
7 mm	9/32"	14.6	19.8
8 mm	5/16"	21.8	29.6
9 mm	11/32"	28.0	38.0
10 mm	3/8"	38.7	52.5
12 mm	1/2"	65.6	89.0
14 mm	9/16"	99.6	135
16 mm	5/8"	151	205
18 mm	11/16"	190	257
20 mm	3/4"	264	358
22 mm	7/8"	321	435
24 mm	15/16"	411	557

FIGURE 5 - Bolt & Cap Screw Torque Ratings

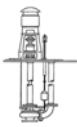

NKS & WS THRUST BEARING ASSEMBLY

The chart shown in Figure 6 gives the SKF part numbers for bearings in American-Marsh NKS & WS pumps.

BEARING INSTALLATION

Mounting of bearings on shafts must be done in a clean environment. Bearing and power end life can be drastically reduced if even very small foreign particles work their way into the bearings.

Bearings should be removed from their protective packaging only immediately before assembly to limit exposure to possible contamination. After removing the packaging they should only come in contact with clean hands, fixtures, tools and work surfaces.

- Slide the thrust bearing cap (#85S) and the thrust bearing housing cap gasket onto the thrust bearing adapter (#92S). Install the thrust bearing (#81P) onto the bearing adapter (#92S) using a press or bearing heater. The thrust bearing (#81P) must be positioned against the shoulder on the shaft (#41A). Install the thrust bearing lockwasher (#91S) and thrust bearing locknut (#89S).

Model	Type of Bearings	Thrust Bearing ^④
1.5x2-6 NKS 2x2.5-6 NKS 2x2.5-8 NKS	Regreasable – Single Shielded ^① Greased for life – Double Shielded ^② Sealed for life – Double Sealed ^③	6307-ZC3 6307-2ZC3 6307-2RSIC3
1.5x2-8 NKS 2.5x3-6 NKS 2.5x3-8 NKS 3x4-8 NKS 4x5-10 NKS	Regreasable – Single Shielded ^① Greased for life – Double Shielded ^② Sealed for life – Double Sealed ^③	6310-ZC3 6310-2ZC3 6310-2RSIC3
3x4-10 WS 4x5-12 WS	Regreasable – Single Shielded ^① Greased for life – Double Shielded ^② Sealed for life – Double Sealed ^③	7308-ZC3 7308-2ZC3 7308-2RSIC3
5x6-14 WS 6x6-14 WS	Regreasable – Single Shielded ^① Greased for life – Double Shielded ^② Sealed for life – Double Sealed ^③	7312-ZC3 7312-2ZC3 7312-2RSIC3

FIGURE 6 – AMP NKS & WS Bearings

^①These bearings are pre-greased by American-Marsh. Replacement bearings will generally not be pre-greased, so grease must be applied by the user. They have a single shield, which is located on the side next to the grease buffer, or reservoir. The bearings draw grease from the reservoir as it is needed. The shield protects the bearing from getting too much grease, which would generate heat. The grease reservoir is initially filled with grease by American-Marsh. Lubrication fittings are provided, to allow the customer to periodically replenish the grease, as recommended by the bearing and/or grease manufacturer.

^②These bearings are shielded on both sides. They come pre-greased by the bearing manufacturer. The user does not need to re-grease these bearings. The shields do not actually contact the bearing race, so no heat is generated.

^③These bearings are sealed on both sides. They come pre-greased by the bearing manufacturer. The user does not need to re-grease these bearings. The seals physically contact and rub against the bearing race, which generates heat. These bearings are not recommended at speeds above 1750 RPM.

^④The codes shown are SKF codes. Inboard and outboard bearings have the C3, greater than "Normal" clearance. These clearances are recommended by SKF to maximize bearing life.

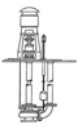

BEARING INSTALLATION FOR POWER END ASSEMBLY (CONT'D)

The thrust bearing has a slight interference fit which requires that they be pressed on the shaft with an arbor or hydraulic press. Even force should be applied to the inner race only. Never press on the outer race, as the force will damage the balls and races. An alternate method of installing bearings is to heat the bearings to 200°F (93°C) in an oven or induction heater. Then place them quickly in position on the shaft.

CAUTION

Never heat the bearings above 230°F (110°C). To do so will likely cause the bearing fits to permanently change, leading to early failure.

- Using clean gloves, install the thrust bearing (#121) firmly against the shaft shoulder. If hot bearing mounting techniques are used, steps must be taken to ensure the outboard bearing is firmly positioned against the shaft shoulder. The outboard bearing, while still hot, is to be positioned against the shaft shoulder. After the bearing has cooled below 100°F (38°C) the bearing should be pressed against the shaft shoulder. An approximate press force needed to seat the bearing is listed in Figure 19. This value may be used if the press has load measuring capability.

CAUTION

It must be understood that fixtures and equipment used to press the bearing must be designed so no load is ever transmitted through the bearing balls. This would damage the bearing.

Bearing Size	Press Force lbf (N)
6307 6310	1300 (5,780)
7308	2500 (11,100)
7312	4500 (20,000)

FIGURE 7 – Bearing Press Force

- If the thrust bearing is cold pressed against the shaft shoulder, it should be pressed onto the shaft with the forces listed in Figure 7.
- The thrust bearing adapter assembly, consisting of the thrust bearing adapter (#92S), the thrust bearing housing cap (#85S), the thrust bearing lockwasher (#91S), the thrust bearing locknut (#89S) and the thrust bearing housing gasket, can now be installed into the thrust bearing housing (#82S) by pressing into position. Install four capscrews to secure the thrust bearing housing cap (#85S) to the thrust bearing housing (82S).
- Install two set screws into thrust bearing adapter (#92S) to secure shaft (#41A) later during assembly.
- Press the thrust bearing housing oil lip seal (#100N) into the bottom of the thrust bearing housing (#82R).
- Mount the thrust bearing housing assembly to the cover plate (#221A).

LABYRINTH SEALS

Refer to Appendix A.

NKS & WS WET END ASSEMBLY

Refer to the appropriate section according to construction details.

- Mount the appropriate support pipe (#280A) and intermediate bearing housings (#82R), with intermediate bearings (#81R), in the proper sequence to the cover plate (#221B).
- Mount the inboard head (#2B), with inboard head bearing (#45C) to the bottom support pipe.
- Install the impeller key (#24A) onto the shaft (#41A). Mount the impeller (#11C) to the shaft assembly (#41A) and secure with impeller lock washer (#27A) and locknut (#24B).
- Slide the impeller and shaft assembly through the inboard head bearing and through the intermediate bearings ensuring that the shaft clears the cover plate (#221B).
- Ensure that the impeller (#11C) has ample clearance off of the inboard head (#2B) (approximately 0.020 inches to 0.030 inches) and lock rotor assembly to thrust bearing housing assembly using set screws located in the thrust bearing adapter (#92S). Ensure that the rotating assembly is free to rotate 360°.
- Dimple the motor shaft at one of the set screw locations (#47A). Install all shaft set screws (#47A) by applying a small amount of blue Loctite on the threads. Torque the set screws (#47A) to the appropriate values listed in Figure 8.

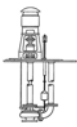

Size	Seating Torque	Holding Power
in.	in.-lbs.	lb.
0.2500	87	1000
0.3125	165	1500
0.3750	290	2000
0.4375	430	2500
0.5000	620	3000
0.5625	620	3500
0.6250	1325	4000
0.7500	2400	5000
0.8750	5200	6000
1.0000	7200	7000

Based on alloy steel set screw against steel shaft, class 3A course or fine threads in class 2B holes and cup point socket set screws.

and the cost of the spare part. Figure 10 give the parts list for a typical NKS & WS pumps.

HOW TO ORDER SPARE PARTS

Spare parts can be ordered from the local American-Marsh Sales Engineer, or from the American-Marsh Distributor or Representative. The pump size and type can be found on the name plate on the motor stand. See Figure 3. Please provide the item number, description, and alloy for the part(s) to be ordered.

To make parts ordering easy, American-Marsh has created a catalog titled “American-Marsh Pump Parts Catalog.” A copy of this book can be obtained from the local American-Marsh Sales Engineer or Distributor/Representative.

FIGURE 8 – Bearing Press Force

14. Install casing o-ring (#351C) onto the register of the inboard head (#2B). Place the casing up onto the rear cover (#2B) and tighten casing cap screws. The rotating assembly **MUST** be able to rotate freely the entire 360°. If this is not the case, the pump **MUST** be disassembled and inspected.
15. Install the suction strainer (#424A) if supplied.
16. Mount the discharge elbow (#441A) to the casing discharge flange.
17. Mount the discharge pipe (#260A) to the discharge elbow (#441A). Newer NKS & WS models have the discharge pipe (#260A) welded to the surface plate (#221B).
18. The float switch assembly consists of the float switch (#301A), the float (#309A), the float rod guide (#304A), the float rod (#303A), the four float rod stops (#307A), the float switch bracket (#302A) and the float rod box nut (#306A) assembly. The entire float switch assembly can be re-installed to the pump assembly at this time.

PUMP REINSTALLATION

The pump is now ready to be returned to service. It should be reinstalled as described in the installation section.

SPARE PARTS

RECOMMENDED SPARE PARTS – STANDARD NKS & WS PUMP

The decision on what spare parts to stock varies greatly depending on many factors such as the criticality of the application, the time required to buy and receive new spares, the erosive/corrosive nature of the application, ENGINEERED PROCESS GROUP

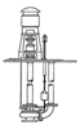

APPENDIX B

AMERICAN-MARSH NKS & WS MAINTENANCE INSTRUCTIONS BEARING HOUSING OIL SEALS (LABYRINTH TYPE) INPRO/SEAL® VBXX BEARING ISOLATORS

INTRODUCTION

American-Marsh Pumps provides pumps fitted with a variety of labyrinth oil seals. While these instructions are written specifically for the Inpro/Seal VBXX labyrinth, they also apply to seals of other manufacturers. Specific installation instructions included with the seal, regardless of manufacturer, should be observed.

The Inpro “VBXX” Bearing Isolator is a labyrinth type seal which isolates the bearings from the environment (uncontaminated), and retains the oil in the bearing housing. The bearing isolator consists of a rotor and a stator. The rotor revolves with the shaft, driven by a close fitted drive ring that rotates with the shaft. The stator is a stationary component that fits into the housing bore with a press fit (nominal 0.002 in (0.05 mm) interference) and with an “O” ring gasket seal. The two pieces are assembled as a single unit, and are axially locked together by an “O” ring. There is no mechanical contact between the rotor and stator when the isolator is running.

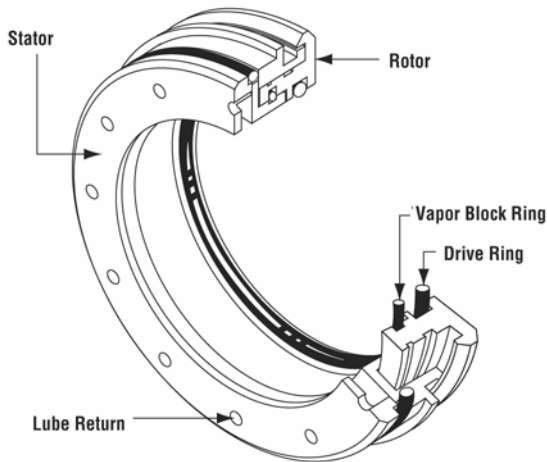

FIGURE 9 – Bearing Isolator

The VBXX is not intended to be separated from the bearing housing/adapter/carrier unless being replaced.

1. If the VBXX is removed from the housing, for any reason, it must be replaced with a new VBXX to ensure a perfect seal with the housing bore.

2. Repair or replacement of the seals is only necessary when excessive oil leakage is evident. However, if for any other reason, the bearing housing is to be disassembled or the pump shaft removed, it is recommended that the rotor “O” rings (which seal on the shaft) be replaced. Spare or replacement “O” rings may be obtained from “Inpro” distributors.

The “Inpro” VBXX bearing isolator is a one piece assembly. The rotor must not pull out of the stator. If the rotor can be removed, the complete seal assembly must be replaced.

3. If the bearing housing or bearing carrier with bronze VBXX seals is washed or cleaned using a caustic type bath, the bronze material may discolor (turn black). If this happens, the complete seal assembly must be replaced.

Note: This may occur if the housing is left in a caustic bath over a long period of time (more than 8 hours).

4. To remove the VBXX bearing isolator:
 - A. Remove the pump shaft as described in the pump disassembly instructions.
 - B. From the inside of the bearing housing or bearing carrier, place a bar (made from a soft material such as wood or plastic) against the inside face of the seal. Push the seal out by tapping the bar with a soft mallet or an arbor press.
5. To install a new VBXX bearing isolator, in the impeller end of the bearing housing/adapter:
 - A. Position the impeller end (inboard) seal in the bore of the adapter or bearing housing with the **single expulsion port at the 6 o’clock position**, (carefully keep aligned with the bore).
 - B. The seal stator O.D. press fits into the bore. Use an arbor press. Place a block or bar (large enough to protect the rotor flange) between the arbor press ram and seal face. Press the seal down into the bore stopping at the shoulder on the stator O.D.

The elastomer “O” ring acts as a gasket to ensure damming up of small imperfections in the housing bore. The “O” ring is designed to be compressed to the point of overfilling its groove. The overfilled material is sheared off during assembly. Remove any sheared “O” ring material which may extrude from the bore.

6. To install a new VBXX bearing isolator in the drive end (outboard) side of the bearing carrier:
 - A. Position the outboard seal in the bore of the bearing cap (no orientation of the

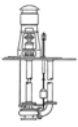

multiple expulsion ports is necessary) and carefully keep aligned with the bore. If the outboard seal has only one expulsion port, that port must be oriented at the 6 o'clock position.

Because the bearing carrier rotates for impeller adjustment, take the necessary steps to ensure the expulsion port is oriented at 6 o'clock when the pump is installed and operating.

B. The seal stator O.D. press fits into the bore. Use an arbor press. Place a block or bar (large enough to protect the rotor flange) between the arbor press ram and seal face. Press the seal down into the bore stopping at the shoulder on the stator O.D. Remove any sheared o-ring material which may extrude from the bore.

7. Assemble the bearing carrier/VBXX bearing isolator on to the shaft:
 - A. Using sand paper, remove burrs and break any sharp edges off the keyway at end of the shaft.
 - B. It is important to prevent the corners of the keyway from cutting the "O" rings during assembly. This can be accomplished with the use of a half key or a thin flexible sleeve. Lightly lubricate the shaft and slide the bearing cap on to the shaft, pushing on the VBXX rotor, until the bearing is seated.
 - C. Check the position of the rotor (make sure rotor and stator have not separated) and seat the rotor snugly into the stator by hand.

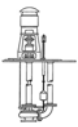
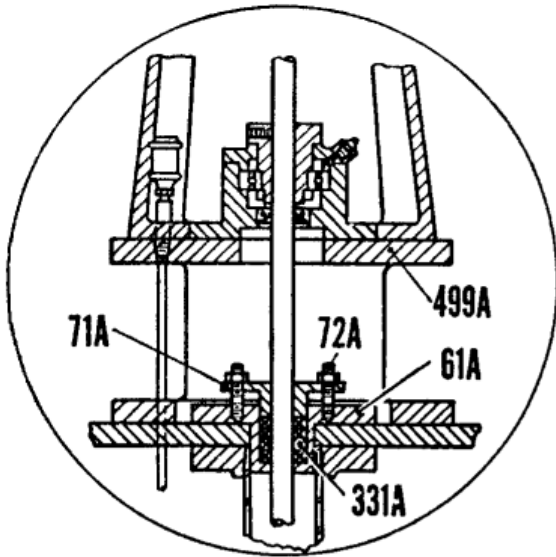
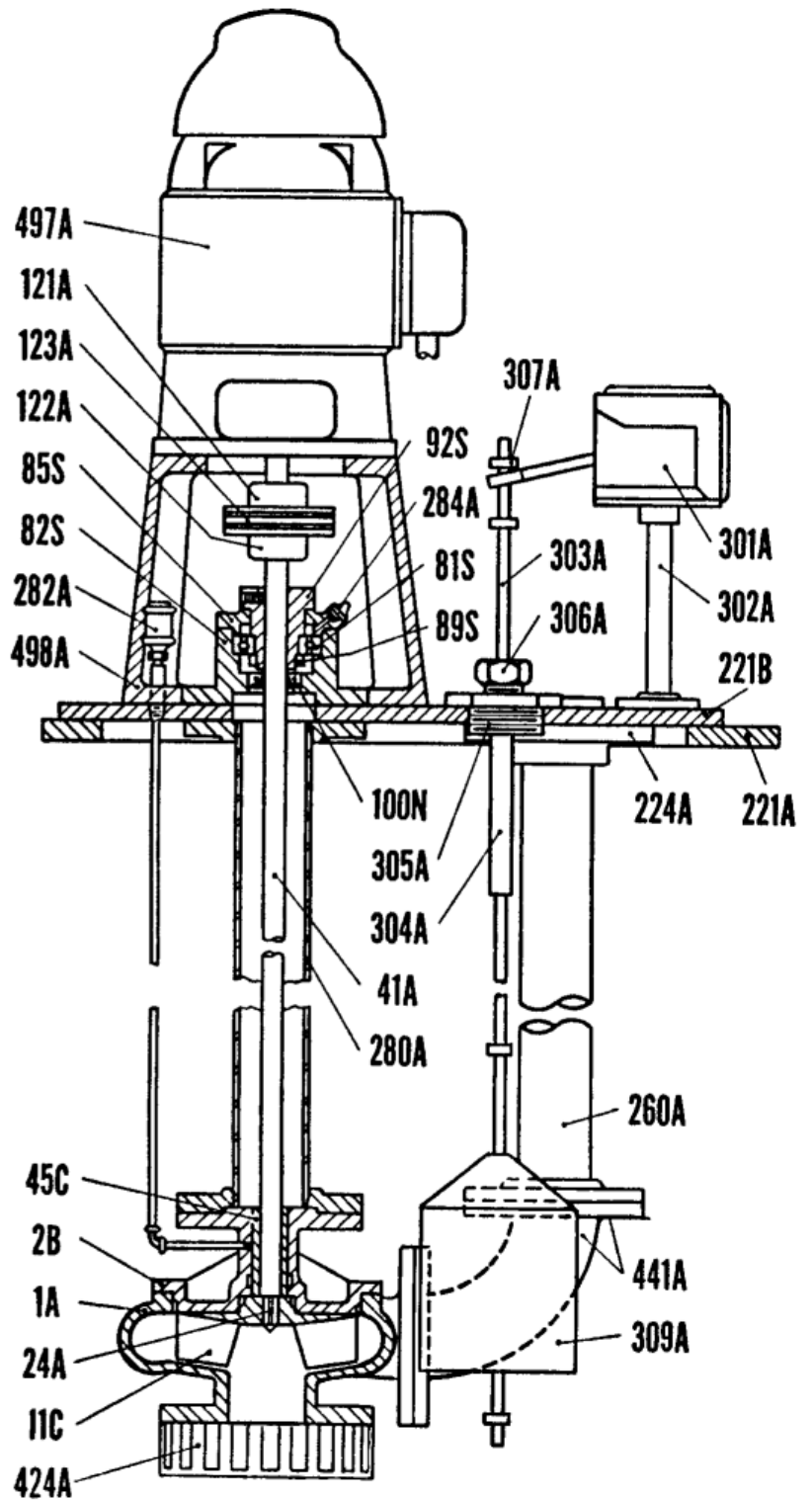
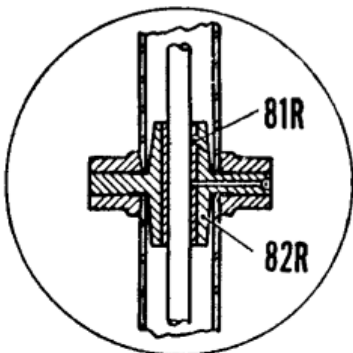

FIGURE 10 – NKS & WS Sectional Drawing



**Construction with Stuffing
Box at Coverplate**

**Intermediate Sleeve Bearing
Construction used on Pit
Depths Over Six Feet**



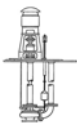

NKS & WS Sectional Drawing

Item Number	Item Description	Num. Req.
1A	Casing	1
2B	Head, Upper Casing	1
11C	Impeller	1
24A	Key, Impeller	1
41A	Shaft, Pump	1
45C	Bearing, Casing Head	1
61A	Box, Stuffing	1
71A	Gland, Stuffing Box	1
72A	Stud, Gland, with Nut	2
81R	Bearing, Intermediate	Varies
81S	Bearing, Ball Thrust	1
82R	Housing, Intermediate Bearing	Varies
82S	Housing, Ball Bearing	1
85S	Cap, Bearing Housing	1
89S	Locknut, Ball Bearing	1
*91S	Lockwasher, Ball Bearing	1
92S	Adapter, Ball Bearing	1
100N	Ring, Lube Seal	1
121A	Coupling, Motor	1
122A	Coupling, Pump	1
123A	Disc, Coupling	1
221A	Plate, Sump Cover	1

Item Number	Item Description	Num. Req.
221B	Plate, Sump Mounting	1
224A	Flange, Upper Discharge	1
260A	Pipe, Discharge, Assembly	Varies
280A	Pipe, Support, Assembly	Varies
282A	Oiler	Varies
284A	Fitting, Zerk Grease	1
**301A	Switch, Float	1
302A	Bracket, Float Switch	1
303A	Rod, Float	1
304A	Guide, Float Rod	1
305A	Box, Float Rod Stuffing	1
306A	Gland Nut, Float Rod Box	1
307A	Stop, Float Rod	4
309A	Float	1
331A	Packing, Stuffing Box	1 set
*332A	Packing, Float Rod Box	1 set
424A	Strainer, Suction	1
441A	Elbow, Discharge	1
**497A	Motor	1
498A	Pedestal, Motor	1
499A	Pedestal, Extension	1

* Not shown in sectional.

Recommended spare parts are in BOLD.

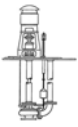

This Page Intentionally Left Blank