

INSTALLATION, OPERATION &  
MAINTENANCE MANUAL  
FOR  
SERIES 300 REC  
SJ CLOSE-COUPLED  
END SUCTION PUMPS

17 FEBRUARY 2005  
Copyright © 2005 American-Marsh Pumps

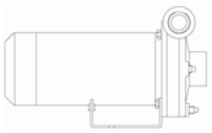

**CONTENTS**

Page #

**SAFETY CONSIDERATIONS ..... 4**

DANGER ..... 4

WARNING ..... 4

CAUTION..... 4

**PUMP IDENTIFICATION ..... 5**

MANUFACTURER ..... 5

TYPE OF PUMP ..... 5

DATE OF MANUFACTURE ..... 5

INSTALLATION, OPERATION & MAINTENANCE MANUAL IDENTIFICATION ..... 5

NAMEPLATE INFORMATION..... 5

**WARRANTY ..... 6**

**GENERAL INSTRUCTIONS..... 6**

**HANDLING AND TRANSPORT ..... 6**

METHOD OF TRANSPORT ..... 6

INSTALLATION ..... 6

**STORAGE..... 6**

SHORT-TERM STORAGE ..... 6

LONG-TERM STORAGE..... 7

**INSTALLATION & ALIGNMENT ..... 7**

FACTORY PRELIMINARY ALIGNMENT PROCEDURE..... 7

RECOMMENDED PROCEDURE FOR BASE PLATE INSTALLATION & FINAL FIELD ALIGNMENT ..... 8

    NEW GROUTED BASE PLATES ..... 8

    EXISTING GROUTED BASE PLATES..... 9

PIPING CONNECTION – SUCTION & DISCHARGE ..... 9

    SUCTION PIPING..... 9

    DISCHARGE PIPING ..... 10

PUMP AND SHAFT ALIGNMENT CHECK..... 10

IMPELLER CLEARANCES..... 10

REC & REI MOTOR ASSEMBLY ..... 10

MECHANICAL SEAL ..... 10

BEARING LUBRICATION ..... 10

    DRIVER BEARINGS..... 10

**PUMP OPERATION ..... 11**

ROTATION CHECK..... 11

PRE START-UP CHECKS..... 11

ENSURING PROPER NPSH<sub>A</sub> ..... 11

MINIMUM FLOW ..... 11

STARTING THE PUMP AND ADJUSTING FLOW ..... 12

OPERATION IN SUB-FREEZING CONDITIONS..... 12

SHUTDOWN CONSIDERATIONS ..... 12

TROUBLESHOOTING ..... 13

**MAINTENANCE..... 17**

PREVENTIVE MAINTENANCE..... 17

NEED FOR MAINTENANCE RECORDS ..... 17

NEED FOR CLEANLINESS..... 17

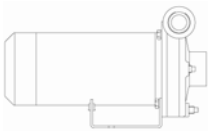

DISASSEMBLY ..... 17  
    *REC-SJ MODELS*..... 17  
CLEANING/INSPECTION ..... 18  
ASSEMBLY ..... 18  
REC-SJ FLUID ASSEMBLY ..... 19  
PUMP REINSTALLATION..... 19

**SPARE PARTS..... 19**

    RECOMMENDED SPARE PARTS – STANDARD REC-SJ PUMP ..... 19  
    HOW TO ORDER SPARE PARTS ..... 19

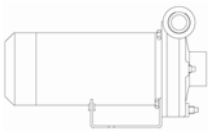

## SAFETY CONSIDERATIONS

The American-Marsh REC-SJ end suction pumps have been designed and manufactured for safe operation. In order to ensure safe operation, it is very important that this manual be read in its entirety prior to installing or operating the pump. American-Marsh Pumps shall not be liable for physical injury, damage or delays caused by a failure to observe the instructions for installation, operation and maintenance contained in this manual.

Remember that every pump has the potential to be dangerous, because of the following factors:

- parts are rotating at high speeds
- high pressures may be present
- high temperatures may be present
- highly corrosive and/or toxic chemicals may be present

Paying constant attention to safety is always extremely important. However, there are often situations that require special attention. These situations are indicated throughout this book by the following symbols:

**! DANGER**

**DANGER** - Immediate hazards which WILL result in severe personal injury or death.

**! WARNING**

**WARNING** – Hazards or unsafe practices which COULD result in severe personal injury or death.

**! CAUTION**

**CAUTION** – Hazards or unsafe practices which COULD result in minor personal injury or product or property damage.

Maximum Lifting Speed: 15 feet/second.

If in a climate where the fluid in the casing could freeze, never leave liquid in the pump casing. Drain the casing completely. During winter months and cold weather, the liquid could freeze and damage the pump casing.  
ENGINEERED PROCESS GROUP

Do not run the equipment dry or start the pump without the proper prime (casing flooded).

Never operate the pump for more than a short interval with the discharge valve closed. The length of the interval depends on several factors including the nature of the fluid pumped and its temperature. Contact American-Marsh Engineering for additional support if required.

Never operate the pump with a closed suction valve.

Excessive pump noise or vibration may indicate a dangerous operating condition. The pump must be shutdown immediately.

Do not operate the pump for an extended period of time below the recommended minimum flow. See Figure 6, page 11.

The pump shaft MUST turn clockwise when viewed from the motor end. It is absolutely essential that the rotation of the motor be checked before installation of the coupling spacer and starting the pump. Incorrect rotation of the pump for even a short period of time can unscrew the impeller nut, which can cause severe damage.

If the liquid is hazardous, take all necessary precautions to avoid damage and injury before emptying the pump casing.

Residual liquid may be found in the pump casing, head and suction line. Take the necessary precautions if the liquid is hazardous, flammable, corrosive, poisonous, infected, etc.

Always lockout power to the driver before performing pump maintenance.

Never operate the pump without the coupling guard and all other safety devices correctly installed.

Do not apply heat to disassemble the pump or to remove the impeller. Entrapped liquid could cause an explosion.

If any external leaks are found while pumping hazardous product, immediately stop operations and repair.

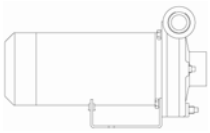

pumps are of the close-coupled, center-line discharge type.

## PUMP IDENTIFICATION

### MANUFACTURER

American-Marsh Pumps  
185 Progress Road  
Collierville, TN 38017  
United States of America

### TYPE OF PUMP

The American-Marsh REC-SJ end suction pumps are end suction, single stage centrifugal pumps. The REC

### DATE OF MANUFACTURE

The date of manufacture is indicated on the pump data plate.

### INSTALLATION, OPERATION & MAINTENANCE MANUAL IDENTIFICATION

Prepared: February, 2005  
Revision:

Edition: 01  
Date of Revision:

### NAMEPLATE INFORMATION

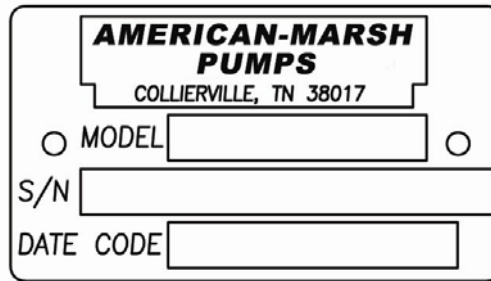
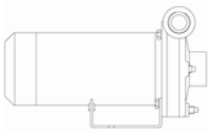

FIGURE 1 – Pump Data Plate

- MODEL : Pump type (REC).
- SERIAL NUMBER : Serial Number of pump unit (issued by Production Control).
- DATE CODE : Date of manufacture.



In case of doubt, contact the manufacturer.

## WARRANTY

American-Marsh Pumps guarantees that only high quality materials are used in the construction of our pumps and that machining and assembly are carried out to high standards.

The pumps are guaranteed against defective materials and/or faulty craftsmanship for a period of one year from the date of shipment unless specifically stated otherwise.

Replacement of parts or of the pump itself can only be carried out after careful examination of the pump by qualified personnel.

**The warranty is not valid if third parties have tampered with the pump.**

This warranty does not cover parts subject to deterioration or wear and tear (mechanical seals, pressure and vacuum gauges, rubber or plastic items, bearings, etc.) or damage caused by misuse or improper handling of the pump by the end user.

Parts replaced under warranty become the property of American-Marsh Pumps.

Contact the American-Marsh Pumps' factory:

**American-Marsh Pumps**  
185 Progress Road  
Collierville, TN 38017  
United States Of America

**Phone:** (901) 860-2300  
**Fax:** (901) 860-2323  
**www.american-marsh.com**

## GENERAL INSTRUCTIONS

The pump and motor unit must be examined upon arrival to ascertain any damage caused during shipment. If damaged immediately notify the carrier and/or the sender. Check that the goods correspond exactly to the description on the shipping documents and report any differences as soon as possible to the sender. Always quote the pump type and serial number stamped on the data plate.

**The pumps must be used only for applications for which the manufacturers have specified:**

- ❖ **The construction materials**
- ❖ **The operating conditions (flow, pressure, temperature, etc.)**
- ❖ **The field of application**

## HANDLING AND TRANSPORT

### METHOD OF TRANSPORT

The pump must be transported in the horizontal position

### INSTALLATION

During installation and maintenance, all components must be handled and transported securely by using suitable slings. Handling must be carried out by specialized personnel to avoid damage to the pump and persons. The lifting rings attached to various components should be used exclusively to lift the components for which they have been supplied.



**Maximum lifting speed: 15 feet/second**

## STORAGE

### SHORT-TERM STORAGE

Normal packaging is designed to protect the pump during shipment and for dry, indoor storage for up to two months or less. The procedure followed for this short-term storage is summarized below:

Standard Protection for Shipment :

- a. Loose unmounted items, including, but not limited to, oilers, packing, coupling spacers, stilts, and mechanical seals are packaged in a water proof plastic bag and placed under the coupling guard. Larger items are cartoned and metal banded to the base plate. For pumps not mounted on a base plate, the bag and/or carton is placed inside the shipping carton. All parts bags and cartons are identified with the American-Marsh sales order number, the customer purchase order number, and the pump item number (if applicable).
- b. Inner surfaces of the bearing housing, shaft (area through bearing housing), and bearings are coated with Cortec VCI-329 rust inhibitor, or equal.

**Note: Bearing housings are not filled with oil prior to shipment.**

- c. Regreasable bearings are packed with grease (Royal Purple NLGI#2).
- d. After a performance test, if required, the pump is tipped on the suction flange for drainage (some residual water may remain in the casing). Then, internal surfaces of ferrous casings, covers,

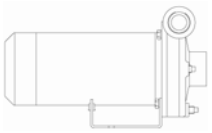

- flange faces, and the impeller surface are sprayed with Calgon Vestal Labs RP-743m, or equal. Exposed shafts are taped with Polywrap.
- e. Flange faces are protected with plastic covers secured with plastic drive bolts. 3/16 in (7.8 mm) steel or 1/4 in (6.3 mm) wood covers with rubber gaskets, steel bolts, and nuts are available at extra cost.
  - f. All assemblies are bolted to a wood skid which confines the assembly within the perimeter of the skid.
  - g. Assemblies with special paint are protected with a plastic wrap.
  - h. Group 1 and Group 2 bare pumps, when not mounted on base plates, are packed in hard paper cartons mounted on wood skids.
  - i. Group 3 bare pumps, when not mounted on base plates, are bolted to wood skids.
  - j. All pump assemblies utilizing polycrystalline base plates are mounted on wood skids.
  - k. All assemblies having external piping (seal flush and cooling water plans), etc. are packaged and braced to withstand normal handling during shipment. In some cases components may be disassembled for shipment. The pump must be stored in a covered, dry location.

### **LONG-TERM STORAGE**

Long-term storage is defined as more than two months, but less than 12 months. The procedure American-Marsh follows for long-term storage of pumps is given below. These procedures are in addition to the short-term procedure.

Solid wood skids are utilized. Holes are drilled in the skid to accommodate the anchor bolt holes in the base plate, or the casing and bearing housing feet holes on assemblies less base plate. Tackwrap sheeting is then placed on top of the skid and the pump assembly is placed on top of the Tackwrap. Metal bolts with washers and rubber bushings are inserted through the skid, the Tackwrap, and the assembly from the bottom of the skid and are then secured with hex nuts. When the nuts are “snugged” down to the top of the base plate or casing and bearing housing feet, the rubber bushing is expanded, sealing the hole from the atmosphere. Desiccant bags are placed on the Tackwrap. The Tackwrap is drawn up around the assembly and hermetically (heat) sealed across the top. The assembly is completely sealed from the atmosphere and the desiccant will absorb any entrapped moisture. A solid wood box is then used to cover the assembly to provide protection from the elements and handling. This packaging will provide protection up to twelve months without damage to mechanical seals, bearings, lip seals, etc. due to humidity, salt laden air, dust, etc. After unpacking, protection will be the responsibility of the ENGINEERED PROCESS GROUP

user. Addition of oil to the bearing housing will remove the inhibitor. If units are to be idle for extended periods after addition of lubricants, inhibitor oils and greases should be used.

**Every three months, the shaft should be rotated approximately 10 revolutions.**

## **INSTALLATION & ALIGNMENT**

### **FACTORY PRELIMINARY ALIGNMENT PROCEDURE**

The purpose of factory alignment is to ensure that the user will have full utilization of the clearance in the motor holes for final job-site alignment. To achieve this, the factory alignment procedure specifies that the pump be aligned in the horizontal plane to the motor, with the motor foot bolts centered in the motor holes. This procedure ensures that there is sufficient clearance in the motor holes for the customer to field align the motor to the pump, to zero tolerance. This philosophy requires that the customer be able to place the base in the same condition as the factory. Thus the factory alignment will be done with the base sitting in an unrestrained condition on a flat and level surface. This standard also emphasizes the need to ensure the shaft spacing is adequate to accept the specified coupling spacer. The factory alignment procedure is summarized below:

1. The base plate is placed on a flat and level work bench in a free and unstressed position.
  2. The base plate is leveled as necessary. Leveling is accomplished by placing shims under the rails (or, feet) of the base at the appropriate anchor bolt hole locations. Levelness is checked in both the longitudinal and lateral directions.
  3. The motor and appropriate motor mounting hardware is placed on the base plate and the motor is checked for any planar soft-foot condition. If any is present it is eliminated by shimming.
  4. The motor feet holes are centered around the motor mounting fasteners.
  5. The motor is fastened in place by tightening the nuts on two diagonal motor mounting studs.
  6. The pump is put onto the base plate and leveled. The foot piece under the bearing housing is adjustable. It is used to level the pump, if necessary. If an adjustment is necessary, we add or delete shims (#109A) between the foot piece and the bearing housing.
  7. The spacer coupling gap is verified.
- 24052  
SERIES 300 – REC-SJ CLOSE-COUPLED

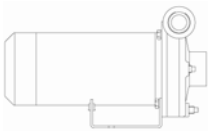

8. The parallel and angular *vertical* alignment is made by shimming under the motor.
9. All four motor feet are tightened down.
10. The pump and motor shafts are then aligned *horizontally*, both parallel and angular, by *moving the pump* to the fixed motor. The pump feet are tightened down.
11. Both horizontal and vertical alignment are again final checked as is the coupling spacer gap.

**RECOMMENDED PROCEDURE FOR BASE PLATE INSTALLATION & FINAL FIELD ALIGNMENT**

**NEW GROUDED BASE PLATES**

1. The pump foundation should be located as close to the source of the fluid to be pumped as practical. There should be adequate space for workers to install, operate, and maintain the pump. The foundation should be sufficient to absorb any vibration and should provide a rigid support for the pump and motor. Recommended mass of a concrete foundation should be three times that of the pump, motor and base. Note that foundation bolts are imbedded in the concrete inside a sleeve to allow some movement of the bolt.
2. Level the pump base plate assembly. If the base plate has machined coplanar mounting surfaces, these machined surfaces are to be referenced when leveling the base plate. This may require that the pump and motor be removed from the base plate in order to reference the machined faces. If the base plate is without machined coplanar mounting surfaces, the pump and motor are to be left on the base plate. The proper surfaces to reference when leveling the pump base plate assembly are the pump suction and discharge flanges. **DO NOT** stress the base plate. Do not bolt the suction or discharge flanges of the pump to the piping until the base plate foundation is completely installed. If equipped, use leveling jackscrews to level the base plate. If jackscrews are not provided, shims and wedges should be used (see Figure 2). Check for levelness in both the longitudinal and lateral directions. Shims should be placed at all base anchor bolt locations, and in the middle edge of the base if the base is more than five feet long. Do not rely on the bottom of the base plate to be flat. Standard base plate bottoms are not machined, and it

is not likely that the field mounting surface is flat.

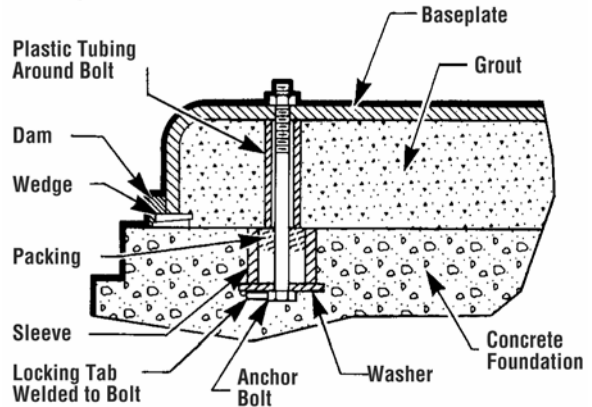

**FIGURE 2 – Base Plate Foundation**

3. After leveling the base plate, tighten the anchor bolts. If shims were used, make sure that the base plate was shimmed near each anchor bolt before tightening. Failure to do this may result in a twist of the base plate, which could make it impossible to obtain final alignment. Check the level of the base plate to make sure that tightening the anchor bolts did not disturb the level of the base plate. If the anchor bolts did change the level, adjust the jackscrews or shims as needed to level the base plate. Continue adjusting the jackscrews or shims and tightening the anchor bolts until the base plate is level.
4. Check initial alignment. If the pump and motor were removed from the base plate proceed with step 5 first, then the pump and motor should be reinstalled onto the base plate using American-Marsh's Factory Preliminary Alignment Procedure, and then continue with the following. As described above, pumps are given a preliminary alignment at the factory. This preliminary alignment is done in a way that ensures that, if the installer duplicates the factory conditions, there will be sufficient clearance between the motor hold down bolts and motor foot holes to move the motor into final alignment. If the pump and motor were properly reinstalled to the base plate or if they were not removed from the base plate and there has been no transit damage, and also if the above steps were done properly, the pump and driver should be within 0.015 in (0.38 mm) FIM (Full Indicator Movement) parallel, and 0.0025 in/in (0.0025 mm/mm) FIM angular. If this is not the case first

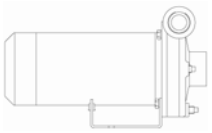

check to see if the driver mounting fasteners are centered in the driver feet holes. If not, recenter the fasteners and perform a preliminary alignment to the above tolerances by shimming under the motor for vertical alignment, and by moving the pump for horizontal alignment.

5. Grout the base plate. A non-shrinking grout should be used. Make sure that the grout fills the area under the base plate. After the grout has cured, check for voids and repair them. Jackscrews, shims and wedges should be removed from under the base plate at this time. If they were to be left in place, they could rust, swell, and cause distortion in the base plate.
6. Run piping to the suction and discharge of the pump. There should be no piping loads transmitted to the pump after connection is made. Recheck the alignment to verify that there are no significant loads.
7. Perform final alignment. Check for soft-foot under the driver. An indicator placed on the coupling, reading in the vertical direction, should not indicate more than 0.002 in (0.05 mm) movement when any driver fastener is loosened. Align the driver first in the vertical direction by shimming underneath its feet. When satisfactory alignment is obtained the number of shims in the pack should be minimized. It is recommended that no more than five shims be used under any foot. Final horizontal alignment is made by moving the driver. Maximum pump reliability is obtained by having near perfect alignment. American-Marsh recommends no more than 0.002 in (0.05mm) parallel, and 0.0005 in/in (0.0005 mm/mm) angular misalignment.
8. Operate the pump for at least an hour or until it reaches final operating temperature. Shut the pump down and recheck alignment while the pump is hot. Piping thermal expansion may change the alignment. Realign pump as necessary.

#### EXISTING GROUTED BASE PLATES

When a pump is being installed on an existing grouted base plate, the procedure is somewhat different from the previous section "New Grouted Base Plates."

1. Mount the pump on the existing base plate.
2. Level the pump by putting a level on the discharge flange. If not level, add or delete shims (#109A) between the foot piece and the bearing housing.
3. Check initial alignment. (Step 4 above)

4. Run piping to the suction and discharge flanges of the pump. (Step 6 above)
5. Perform final alignment. (Step 7 above)
6. Recheck alignment after pump is hot. (Step 8 above)

All piping must be independently supported, accurately aligned and preferably connected to the pump by a short length of flexible piping. The pump should not have to support the weight of the pipe or compensate for misalignment. It should be possible to install suction and discharge bolts through mating flanges without pulling or prying either of the flanges. All piping must be tight. Pumps may air-bind if air is allowed to leak into the piping. If the pump flange(s) have tapped holes, select flange fasteners with thread engagement at least equal to the fastener diameter but that do not bottom out in the tapped holes before the joint is tight.

#### **PIPING CONNECTION – SUCTION & DISCHARGE**

All piping must be independently supported, accurately aligned and preferably connected to the pump by a short length of flexible piping. The pump should not have to support the weight of the pipe or compensate for misalignment. It should be possible to install suction and discharge bolts through mating flanges without pulling or prying either of the flanges. All piping must be tight. Pumps may air-bind if air is allowed to leak into the piping. If the pump flange(s) have tapped holes, select flange fasteners with thread engagement at least equal to the fastener diameter but that do not bottom out in the tapped holes before the joint is tight.

## **WARNING**

**Piping Forces:** Take care during installation and operation to minimize pipe forces and/or moments on the pump casing.

#### SUCTION PIPING

To avoid NPSH and suction problems, suction pipe sizes must be at least as large as the pump suction connection. **Never** use pipe or fittings on the suction that are smaller in diameter than the pump suction size. Figure 3 illustrates the ideal piping configuration with a minimum of 10 pipe diameters between the source and the pump suction. In most cases, horizontal reducers should be eccentric and mounted with the flat side up as shown in figure 6 with a maximum of one pipe size reduction. Never mount eccentric reducers with the flat side down. Horizontally mounted concentric reducers should not be used if there is any possibility of entrained air in the process fluid. Vertically mounted concentric

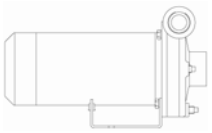

reducers are acceptable. In applications where the fluid is completely deaerated and free of any vapor or suspended solids, concentric reducers are preferable to eccentric reducers.

Avoid the use of throttling valves and strainers in the suction line. Start up strainers must be removed shortly after start up. When the pump is installed below the source of supply, a valve should be installed in the suction line to isolate the pump and to permit pump inspection and maintenance. However, never place a valve directly on the suction nozzle of the pump.

Refer to the American-Marsh Pump Engineering Manual and the Centrifugal Pump IOM Section of the Hydraulic Institute Standards for additional recommendations on suction piping.

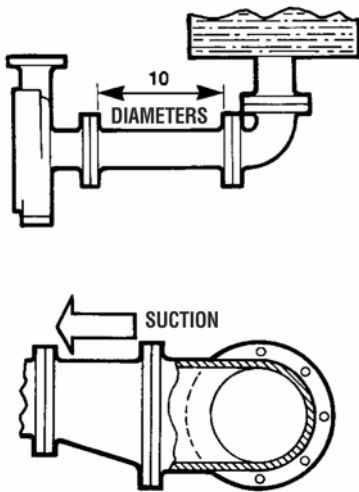

**FIGURE 3 – Good Piping Practices**

**DISCHARGE PIPING**

Install a valve in the discharge line. This valve is required for regulating flow and/or to isolate the pump for inspection and maintenance.

**! WARNING**

*When fluid velocity in the pipe is high, for example, 10 ft/s (3 m/s) or higher, a rapidly closing discharge valve can cause a damaging pressure surge. A dampening arrangement should be provided in the piping.*

**PUMP AND SHAFT ALIGNMENT CHECK**

After connecting piping, rotate the pump drive shaft clockwise (view from motor end) by hand several complete revolutions to be sure there is no binding and that all parts are free. Recheck shaft alignment. If piping caused unit to be out of alignment, correct piping to relieve strain on the pump.

**IMPELLER CLEARANCES**

REC-SJ model pumps do not have impeller clearances that need to be adjusted. The design and assembly of the unit ensure that the impeller is placed in the proper position within the casing assembly.

**REC & REI MOTOR ASSEMBLY**

See section step 6, page 27 for proper motor assembly procedure.

**MECHANICAL SEAL**

When the pump is intended to be equipped with a mechanical seal, it is American-Marsh’s standard practice to install the mechanical seal in the pump prior to shipment. Specific order requirements may specify that the seal be shipped separately, or none be supplied. It is the pump installer’s responsibility to determine if a seal was installed. If a seal was supplied but not installed, the seal and installation instructions will be shipped with the pump.

A flush line from a clean external source should be connected via Tap V, in the top of the stuffing box.

**BEARING LUBRICATION**

Reasonable care and proper lubrication of American-Marsh Pump bearings will result in many years of service.

REC-SJ pumps depend on the driver bearings for support and therefore should be cared for as the manufacturer of the driver recommends.

**DRIVER BEARINGS**

Consult the driver manufacturer’s maintenance instructions for lubricants and re-lubrication procedures for the driver.

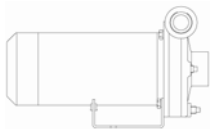

## PUMP OPERATION

### ROTATION CHECK

# CAUTION

It is absolutely essential that the rotation of the motor be checked before connecting the shaft coupling. Incorrect rotation of the pump, for even a short time, can dislodge and damage the impeller, casing, shaft and shaft seal.

All RE pumps turn clockwise as viewed from the motor end. A direction arrow is cast on the front of the casing. Make sure the motor rotates in the same direction.

### PRE START-UP CHECKS

Prior to starting the pump it is essential that the following checks are made. These checks are all described in detail in the Maintenance Section of this booklet.

- Pump and Motor properly secured to the base plate
- All fasteners tightened to the correct torques
- Rotation check, see above  
**THIS IS ABSOLUTELY ESSENTIAL.**
- Shaft seal properly installed
- Pump instrumentation is operational
- Pump is primed
- Rotation of shaft by hand

As a final step in preparation for operation, it is important to rotate the shaft by hand to be certain that all rotating parts move freely, and that there are no foreign objects in the pump.

### ENSURING PROPER NPSH<sub>A</sub>

Net Positive Suction Head – Available (NPSH<sub>A</sub>) is the measure of the energy in a liquid above the vapor pressure. It is used to determine the likelihood that a fluid will vaporize in the pump. It is critical because a centrifugal pump is designed to pump a liquid, not a vapor. Vaporization in a pump will result in damage to the pump, deterioration of the Total Differential Head (TDH), and possibly a complete stopping of pumping. Net Positive Suction Head – Required (NPSH<sub>R</sub>) is the decrease of fluid energy between the inlet of the pump, and the point of lowest pressure in the pump. This decrease occurs because of friction losses and fluid accelerations in the inlet region of the pump, and particularly accelerations as the fluid enters the impeller vanes. The value for NPSH<sub>R</sub> for the specific pump purchased is given in the pump data sheet, and on the pump performance curve.

For a pump to operate properly the NPSH<sub>A</sub> must be greater than the NPSH<sub>R</sub>. Good practice dictates that this margin should be at least 5 ft (1.5 m) or 20%, whichever is greater.

# CAUTION

Ensuring that NPSH<sub>A</sub> is larger than NPSH<sub>R</sub> by the suggested margin will greatly enhance pump performance and reliability. It will also reduce the likelihood of cavitation, which can severely damage the pump.

### MINIMUM FLOW

Minimum continuous stable flow is the lowest flow at which the pump can operate and still conform to the bearing life, shaft deflection and bearing housing vibration limits. Pumps may be operated at lower flows, but it must be recognized that the pump may not conform to one or more of these limits. For example, vibration may exceed the limit set by the ASME standard. The size of the pump, the energy absorbed, and the liquid pumped are some of the considerations in determining the minimum flow.

Typically, limitations of 10% of the capacity at the best efficiency point (BEP) should be specified as the minimum flow. However, American-Marsh has determined that several pumps must be limited to higher minimum flows to provide optimum service. The following are the recommended minimum flows for these specific pumps:

| Pump Size  | 60 Hz |                         | 50 Hz |                         |
|------------|-------|-------------------------|-------|-------------------------|
|            | RPM   | Minimum Flow (% of BEP) | RPM   | Minimum Flow (% of BEP) |
| All Models | 3500  | 25%                     | 2900  | 21%                     |

**FIGURE 6 - Minimum Continuous Safe Flow**

**Note:** “Minimum intermittent flow” value of 50% of the “minimum continuous flow” as long as that flow is greater than the “minimum thermal flow.”

All RE pumps also have a “Minimum Thermal Flow.” This is defined as the minimum flow that will not cause an excessive temperature rise. Minimum Thermal Flow is application dependent.

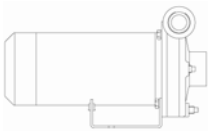

## **! WARNING**

*Do not operate the pump below Minimum Thermal Flow, as this could cause an excessive temperature rise. Contact an American-Marsh Sales Engineer for determination of Minimum Thermal flow.*

### **STARTING THE PUMP AND ADJUSTING FLOW**

1. Open the suction valve to full open position. It is very important to leave the suction valve open while the pump is operating. Any throttling or adjusting of flow must be done through the discharge valve. Partially closing the suction valve can create serious NPSH and pump performance problems.

## **! DANGER**

*Never operate pump with both the suction and discharge valves closed. This could cause an explosion.*

2. A standard centrifugal pump will not move liquid unless the pump is primed. A pump is said to be "primed" when the casing and the suction piping are completely filled with liquid. Open discharge valve a slight amount. This will allow any entrapped air to escape and will normally allow the pump to prime, if the suction source is above the pump. When a condition exists where the suction pressure may drop below the pump's capability, it is advisable to add a low pressure control device to shut the pump down when the pressure drops below a predetermined minimum.
3. All cooling, heating, and flush lines must be started and regulated.
4. Start the driver (typically, the electric motor).
5. Slowly open the discharge valve until the desired flow is reached, keeping in mind the minimum flow restrictions listed above.

## **! DANGER**

*It is important that the discharge valve be opened within a short interval after starting the driver. Failure to do this could cause a dangerous build up of heat, and possibly an explosion.*

6. **Reduced capacity**  
Avoid running a centrifugal pump at drastically reduced capacities or with discharge valve closed for extended periods of time. This can cause severe temperature rise and the liquid in the pump may reach its boiling point. If this occurs, the mechanical seal will be exposed to vapor, with no lubrication, and may score or seize to the stationary parts. Continued running under these conditions when the suction valve is also closed, can create an explosive condition due to the confined vapor at high pressure and temperature. Thermostats may be used to safeguard against over heating by shutting down the pump at a predetermined temperature.

Safeguards should also be taken against possible operation with a closed discharge valve, such as installing a bypass back to the suction source. The size of the bypass line and the required bypass flow rate is a function of the input horsepower and the allowable temperature rise.

7. **Reduced Head**  
Note that when discharge head drops, the pump's flow rate usually increases rapidly. Check motor for temperature rise as this may cause overload. If overloading occurs, throttle the discharge.
8. **Surging Condition**  
A rapidly closing discharge valve can cause a damaging pressure surge. A dampening arrangement should be provided in the piping.

### **OPERATION IN SUB-FREEZING CONDITIONS**

When using the pump in sub-freezing conditions where the pump is periodically idle, the pump should be properly drained or protected with thermal devices which will keep the liquid in the pump from freezing.

### **SHUTDOWN CONSIDERATIONS**

When the pump is being shutdown, the procedure should be the reverse of the start-up procedure. First, slowly close the discharge valve, shutdown the driver,

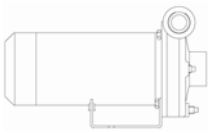

then close the suction valve. Remember, closing the suction valve while the pump is running is a safety hazard and could seriously damage the pump and other equipment.

### ***TROUBLESHOOTING***

The following is a guide to troubleshooting problems with American-Marsh pumps. Common problems are analyzed and solutions are offered. Obviously, it is impossible to cover every possible scenario. If a problem exists that is not covered by one of the examples, then contact a local American-Marsh Sales Engineer or Distributor/Representative for assistance.

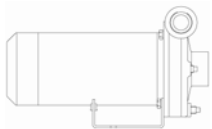

| <b>PROBLEM</b>  | <b>POSSIBLE CAUSE</b>   | <b>RECOMMENDED REMEDY</b>  |
|---|---|--|
| <b>Problem #1</b><br>Pump not reaching design flow rate.    | 1.1<br>Insufficient NPSH <sub>A</sub> . (Noise may not be present)                          | Recalculate NPSH available. It must be greater than the NPSH required by pump at desired flow. If not, redesign suction piping, holding number of elbows and number of planes to a minimum to avoid adverse flow rotation as it approaches the impeller. |
|   | 1.2<br>System head greater than anticipated.  | Reduce system head by increasing pipe size and/ than or reducing number of fittings. Increase impeller diameter. NOTE: Increasing impeller diameter may require use of a larger motor.   |
|   | 1.3<br>Entrained air. Air leak from atmosphere on suction side.                             | 1. Check suction line gaskets and threads for tightness.<br>2. If vortex formation is observed in suction tank, install vortex breaker.<br>3. Check for minimum submergence.   |
|   | 1.4<br>Entrained gas from process.  | Process generated gases may require larger pumps.  |
|   | 1.5<br>Speed too low.   | Check motor speed against design speed.  |
|   | 1.6<br>Direction of rotation wrong.   | After confirming wrong rotation, reverse any two of three leads on a three phase motor. The pump should be disassembled and inspected before it is restarted.  |
|   | 1.7<br>Impeller too small.  | Replace with proper diameter impeller. NOTE: Increasing impeller diameter may require use of a larger motor.   |
|   | 1.8 Plugged impeller, suction line or casing which may be due to a product or large solids. | 1. Reduce length of fiber when possible.<br>2. Reduce solids in the process fluid when possible.<br>3. Consider larger pump.   |
|   | 1.9 Wet end parts (casing cover, impeller) worn, corroded or missing.                       | Replace part or parts.   |
| <b>Problem #2.0</b><br>Pump not reaching design head (TDH). | 2.1<br>Refer to possible causes under Problem #1.0.   | Refer to remedies listed under Problem #1.0 and #3.0.  |
| <b>Problem #3.0</b><br>No discharge or flow                 | 3.1<br>Not properly primed.   | Repeat priming operation, recheck instructions. If pump has run dry, disassemble and inspect the pump before operation.  |
|   | 3.2<br>Direction of rotation wrong.   | After confirming wrong rotation, reverse any two of three leads on a three phase motor. The pump should be disassembled and inspected before operation.  |

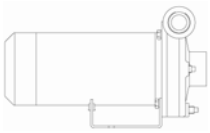

| <b>PROBLEM</b>   | <b>POSSIBLE CAUSE</b>  | <b>RECOMMENDED REMEDY</b>   |
|--|--|---|
| <b>Cont. Problem #3.0</b><br>No discharge or flow                        | 3.3<br>Entrained air. Air leak from atmosphere on suction side.  | Refer to recommended remedy under Problem #1.0, Item #1.3.  |
|  | 3.4<br>Plugged impeller, suction line or casing which may be due to a fibrous product or large solids.   | Refer to recommended remedy under Problem #1.0, Item #1.8.  |
|  | 3.5<br>Damaged pump shaft, impeller.   | Replace damaged parts.  |
| <b>Problem #4.0</b><br>Pump operates for short period, then loses prime. | 4.1<br>Insufficient NPSH.  | Refer to recommended remedy under Problem #1.0, Item #1.1.  |
|  | 4.2<br>Entrained air. Air leak from atmosphere on suction side.  | Refer to recommended remedy under Problem #1.0, Item #1.3.  |
| <b>Problem #5.0</b><br>Excessive noise from wet end.                     | 5.1<br>Cavitation - insufficient NPSH available.   | Refer to recommended remedy under Problem #1.0, Item #1.1.  |
|  | 5.2<br>Abnormal fluid rotation due to complex suction piping.  | Redesign suction piping, holder number of elbows and number of planes to a minimum to avoid adverse fluid rotation as it approaches the impeller.   |
| <b>Problem #6.0</b><br>Excessive noise from power end.                   | 6.1<br>Bearing contamination appearing on the raceways as scoring, pitting, scratching, or rusting caused by adverse environment and entrance of abrasive contaminants from atmosphere.  | 1. Work with clean tools in clean surroundings.<br>2. Remove all outside dirt from housing before exposing bearings.<br>3. Handle with clean dry hands.<br>4. Treat a used bearing as carefully as a new one.<br>5. Use clean solvent and flushing oil.<br>6. Protect disassembled bearing from dirt and moisture.<br>7. Keep bearings wrapped in paper or clean cloth while not in use.<br>8. Clean inside of housing before replacing bearings.<br>9. Check oil seals and replace as required.<br>10. Check all plugs and tapped openings to make sure that they are tight. |
|  | 6.2<br>Brinelling of bearing identified by indentation on the ball races, usually caused by incorrectly applied forces in assembling the bearing or by shock loading such as hitting the bearing or drive shaft with a hammer. | When mounting the bearing on the drive shaft use a proper size ring and apply the pressure against the inner ring only. Be sure when mounting a bearing to apply the mounting pressure slowly and evenly.   |

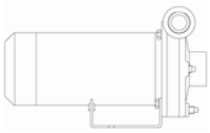

| <b>PROBLEM</b>   | <b>POSSIBLE CAUSE</b>  | <b>RECOMMENDED REMEDY</b>   |
|--|--|---|
| <b>Cont. Problem #6.0</b><br>Excessive noise from power end. | 6.3<br>False brinelling of bearing identified again by either axial or circumferential indentations usually caused by vibration of the balls between the races in a stationary bearing.  | 1. Correct the source of vibration.<br>2. Where bearings are oil lubricated and employed in units that may be out of service for extended periods, the drive shaft should be turned over periodically to re-lubricate all bearing surfaces at intervals of one-to three months.   |
|  | 6.4<br>Thrust overload on bearing identified by flaking ball path on one side of the outer race or in the case of maximum capacity bearings, may appear as a spalling of the races in the vicinity of the loading slot.  | 1. Follow correct mounting procedures for bearings.   |
|  | 6.5<br>Misalignment identified by fracture of ball retainer or a wide ball path on the inner race and a narrower cocked ball path on the outer race. Misalignment is caused by poor mounting practices or defective drive shaft. For example bearing not square with the centerline or possibly a bent shaft due to improper handling. | Handle parts carefully and follow recommended mounting procedures. Check all parts for proper fit and alignment.  |
|  | 6.6<br>Bearing damaged by electric arcing identified as electro-etching of both inner and outer ring as a pitting or cratering. Electrical arcing is caused by a static electrical charge emanating from belt drives, electrical leakage or short circuiting.  | 1. Where current shunting through the bearing cannot be corrected, a shunt in the form of a slip ring assembly should be incorporated.<br>2. Check all wiring, insulation and rotor windings to be sure that they are sound and all connections are properly made.<br>3. Where pumps are belt driven, consider the elimination of static charges by proper grounding or consider belt material that is less generative. |
|  | 6.7<br>Bearing damage due to improper lubrication, identified by one or more of the following:<br>1. Abnormal bearing temperature rise.<br>2. A stiff cracked grease appearance.<br>3. A brown or bluish discoloration of the bearing races.   | 1. Be sure the lubricant is clean.<br>2. Be sure the proper grade of lubricant is used.   |

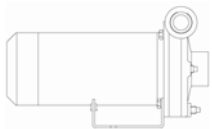

## MAINTENANCE

### PREVENTIVE MAINTENANCE

The following sections of this manual give instructions on how to perform a complete maintenance overhaul. However, it is also important to periodically repeat the "Pre start-up checks" listed on page 11. These checks will help extend pump life as well as the length of time between major overhauls.

### NEED FOR MAINTENANCE RECORDS

A procedure for keeping accurate maintenance records is a critical part of any program to improve pump reliability. There are many variables that can contribute to pump failures. Often long term and repetitive problems can only be solved by analyzing these variables through pump maintenance records.

### NEED FOR CLEANLINESS

One of the major causes of pump failure is the presence of contaminants in the bearing housing. This contamination can be in the form of moisture, dust, dirt and other solid particles such as metal chips. Contamination can also be harmful to the mechanical seal (especially the seal faces) as well as other parts of the pumps. For example, dirt in the impeller threads could cause the impeller to not be seated properly against the shaft. This, in turn, could cause a series of other problems. For these reasons, it is very important that proper cleanliness be maintained. Some guidelines are listed below.

After draining the oil from the bearing housing, periodically send it out for analysis. If it is contaminated, determine the cause and correct. The work area should be clean and free from dust, dirt, oil, grease, etc. Hands and gloves should be clean. Only clean towels, rags, and tools should be used.

### DISASSEMBLY

Refer to the parts list shown in Figure 8 for item number references used throughout this section.

#### REC-SJ MODELS

1. Before performing any maintenance, disconnect the driver from its power supply and lock it off line.

## DANGER

*Lock out power to driver to prevent personal injury.*

2. Close the discharge and suction valves, and drain all liquid from the pump.
3. Close all valves on auxiliary equipment and piping, then disconnect all auxiliary piping.
4. Decontaminate the pump as necessary. If American-Marsh pumps contain dangerous chemicals, it is important to follow plant safety guidelines to avoid personal injury or death.
5. Remove casing fasteners (#383E/F).
6. Move the motor rear cover (#500L) away from the casing (#1A). Discard the casing/cover gasket (#351A).

## DANGER

*The rear cover assembly and shaft & bracket assembly is heavy. It is important to follow plant safety guidelines when lifting it.*

7. Inspect the casing (#1A) and the case wear ring (#15A) for damage. If the casing (#1A) shows any signs of damage, replace it. If the case wear ring (#15A) is damaged, pry it from the casing (#1A). Press new case wear ring (#15A) into casing (#1A) by using equal force around the case wear ring (#15A) until it is seated securely in casing (#1A).
8. Transport the back pull-out assembly to the maintenance shop.
9. Loosen and remove the impeller (#11) from the motor shaft (#41).

## CAUTION

*Do not apply heat to the impeller. If liquid is entrapped in the hub, an explosion could occur.*

10. Remove the mechanical seal (#331B) from the shaft (#41A).
11. Carefully press the stationary part of the mechanical seal (#331B) out of the rear cover

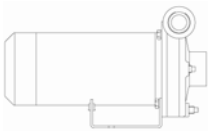

(#500L). Discard and replace the mechanical seal (#331B) if damaged.

- 12. Inspect the rear cover (#500L) for damage or excessive wear and replace if necessary. Be sure to inspect and clean the internal flush port. It is critical that this flush port is clear of all debris due to the fact that it lubricates the mechanical seal (#331B).

### CLEANING/INSPECTION

All parts should now be thoroughly cleaned and inspected. New bearings, O-rings, gaskets, and lip seals should be used. Any parts that show wear or corrosion should be replaced with new genuine American-Marsh parts.



*It is important that only non-flammable, non-contaminated cleaning fluids are used. These fluids must comply with plant safety and environmental guidelines.*

### ASSEMBLY

**Note:** Refer to Figure 7 for all bolt torque information.

It is very important that all pipe threads be sealed properly. PTFE tape provides a very reliable seal over a wide range of fluids, but it has a serious shortcoming if not used properly. If, during application to the threads, the tape is wrapped over the end of the male thread, strings of the tape will be formed off when threaded into the female fitting. This string can then tear away and lodge in the piping system. If this occurs in the seal flush system, small orifices can become blocked effectively shutting off flow. For this reason, American-Marsh does not recommend the use of PTFE tape as a thread sealant.

American-Marsh has investigated and tested alternate sealants and has identified two that provide an effective seal, have the same chemical resistance as the tape, and will not plug flush systems. These are La-co SlicTite and Bakerseal. Both products contain finely ground PTFE particles in an oil based carrier. They are supplied in a paste form which is brushed on the male pipe threads. American-Marsh recommends using one of these paste sealants.

Full thread length engagement is required for all fasteners.

| BOLT SIZE |          | TIGHTENING TORQUE |      |
|-----------|----------|-------------------|------|
| Metric    | Standard | Lbf ft            | Nm   |
| 4 mm      | 5/32"    | 2.7               | 3.6  |
| 5 mm      | 3/16"    | 5.2               | 7.0  |
| 6 mm      | 1/4"     | 8.9               | 12.0 |
| 7 mm      | 9/32"    | 14.6              | 19.8 |
| 8 mm      | 5/16"    | 21.8              | 29.6 |
| 9 mm      | 11/32"   | 28.0              | 38.0 |
| 10 mm     | 3/8"     | 38.7              | 52.5 |
| 12 mm     | 1/2"     | 65.6              | 89.0 |
| 14 mm     | 9/16"    | 99.6              | 135  |
| 16 mm     | 5/8"     | 151               | 205  |
| 18 mm     | 11/16"   | 190               | 257  |
| 20 mm     | 3/4"     | 264               | 358  |
| 22 mm     | 7/8"     | 321               | 435  |
| 24 mm     | 15/16"   | 411               | 557  |

**FIGURE 7 - Bolt & Cap Screw Torque Ratings**

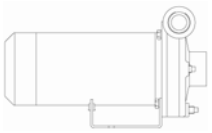

### **REC-SJ FLUID ASSEMBLY**

1. Press the stationary part of the mechanical seal (#331B) into the rear cover (#500L) taking care not to damage the mechanical seal.
2. Install the rotating part of the mechanical seal (#331B) onto the shaft (#41).
3. Install the impeller (#11A) onto the shaft (#41A). Tighten the impeller (#11A) onto the shaft.
4. Install a new casing gasket (#351A) onto the pump. Place the pump casing (#1A) back onto the rear cover (#500L). Tighten casing cap screws (#383E/F).

### **PUMP REINSTALLATION**

The pump is now ready to be returned to service. It should be reinstalled as described in the installation section.

### **SPARE PARTS**

#### **RECOMMENDED SPARE PARTS – STANDARD REC-SJ PUMP**

The decision on what spare parts to stock varies greatly depending on many factors such as the criticality of the application, the time required to buy and receive new spares, the erosive/corrosive nature of the application, and the cost of the spare part. Figure 8 give the parts list for a typical REC-SJ pumps.

#### **HOW TO ORDER SPARE PARTS**

Spare parts can be ordered from the local American-Marsh Sales Engineer, or from the American-Marsh Distributor or Representative. The pump size and type can be found on the name plate on the bearing housing. See Figure 3. Please provide the item number, description, and alloy for the part(s) to be ordered.

To make parts ordering easy, American-Marsh has created a catalog titled “American-Marsh Pump Parts Catalog.” A copy of this book can be obtained from the local American-Marsh Sales Engineer or Distributor/Representative.

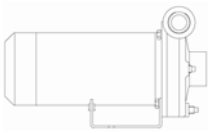
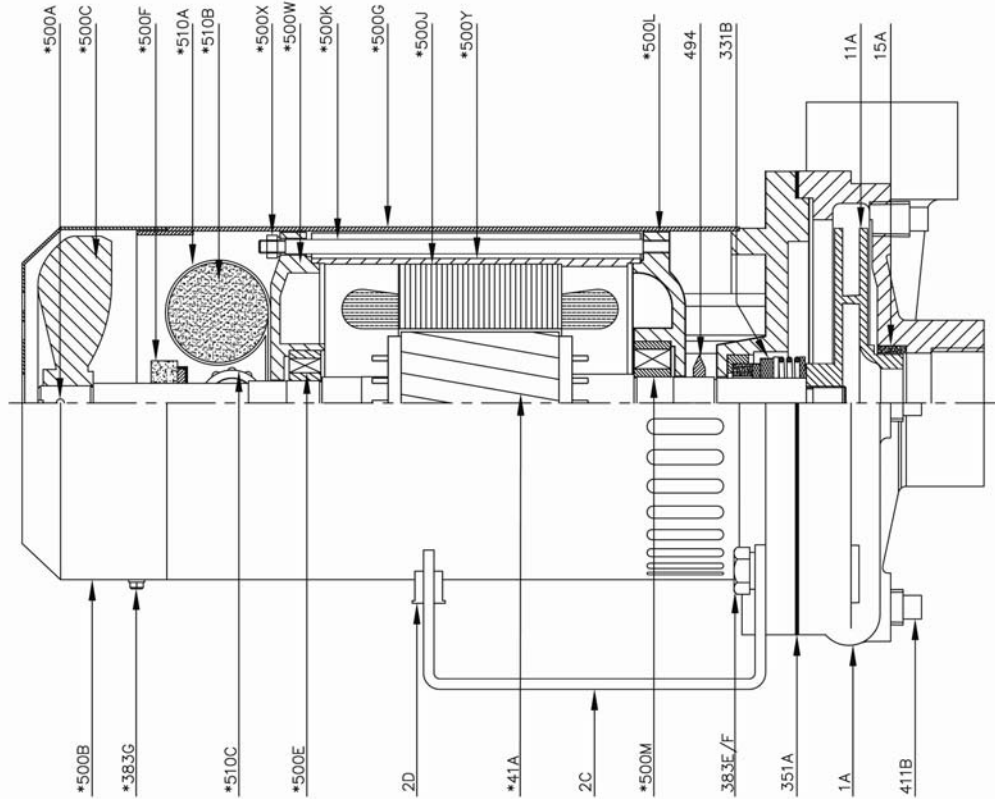

FIGURE 8 – REC-SJ Sectional Drawing



| Item Number | Item Description            | Num. Req. |
|-------------|-----------------------------|-----------|
| 1A          | Casing                      | 1         |
| 2C          | Rubber Foot Mount           | 1         |
| 2D          | Pump Foot                   | 1         |
| <b>11A</b>  | Impeller                    | 1         |
| <b>15A</b>  | Case Wear Ring              | 1         |
| *41A        | Shaft & Rotor Assembly      | 1         |
| <b>331B</b> | Mechanical Seal             | 1         |
| <b>351A</b> | Casing Gasket               | 1         |
| 383E/F      | Casing Stud & Nut           | 4         |
| 411B        | Plug, Drain                 | 1         |
| 494         | Shaft Deflector             | 1         |
| *500A       | Motor Cooling Fan Split Pin | 1         |
| *500B       | Motor Cooling Fan Cover     | 1         |
| *500C       | Motor Cooling Fan           | 1         |

| Item Number | Item Description       | Num. Req. |
|-------------|------------------------|-----------|
| *500F       | Motor Terminal Board   | 1         |
| *510A       | Motor Capacitor Clamp  | 1         |
| *510B       | Motor Capacitor        | 1         |
| *500X       | Motor Hex Nut          | 1         |
| *500W       | Motor Outboard Cap     | 1         |
| *500K       | Motor Tie Rod          | 4         |
| *500G       | Motor Outer Frame      | 1         |
| *500J       | Motor Stator Windings  | 1         |
| *500Y       | Motor Inner Frame      | 1         |
| *500L       | Motor Inboard Cap      | 1         |
| *500M       | Motor Inboard Bearing  | 1         |
| *500E       | Motor Outboard Bearing | 1         |
| *510C       | Motor Wiring Gland     | 1         |

\*American-Marsh motor item.

**Recommended spare parts are in BOLD.**